

TECHNISCHE QUALIFIZIERUNG. GRUNDLAGEN HOCHVOLT-TECHNIK.

3 SICHERHEITSREGELN.

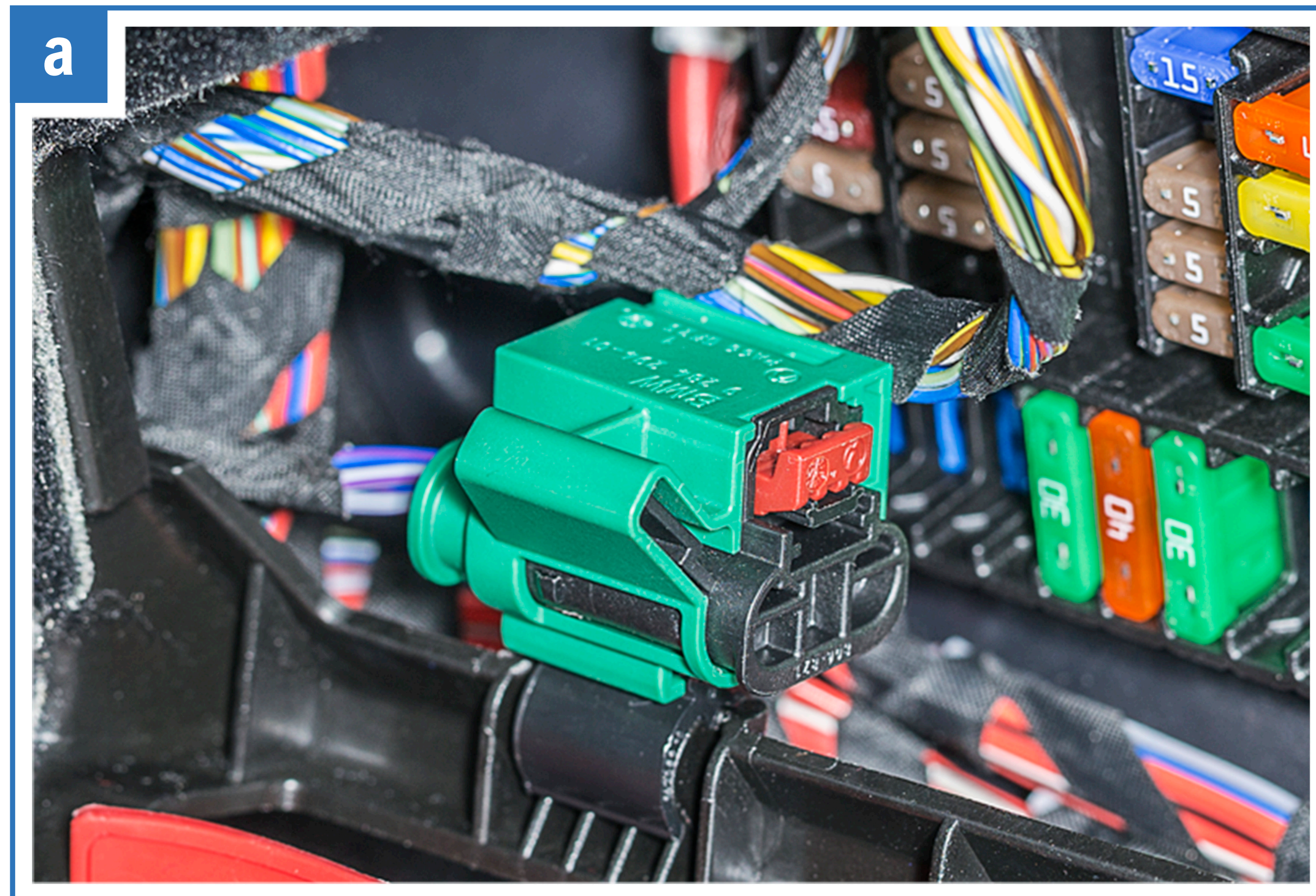

Spannungsfreiheit herstellen

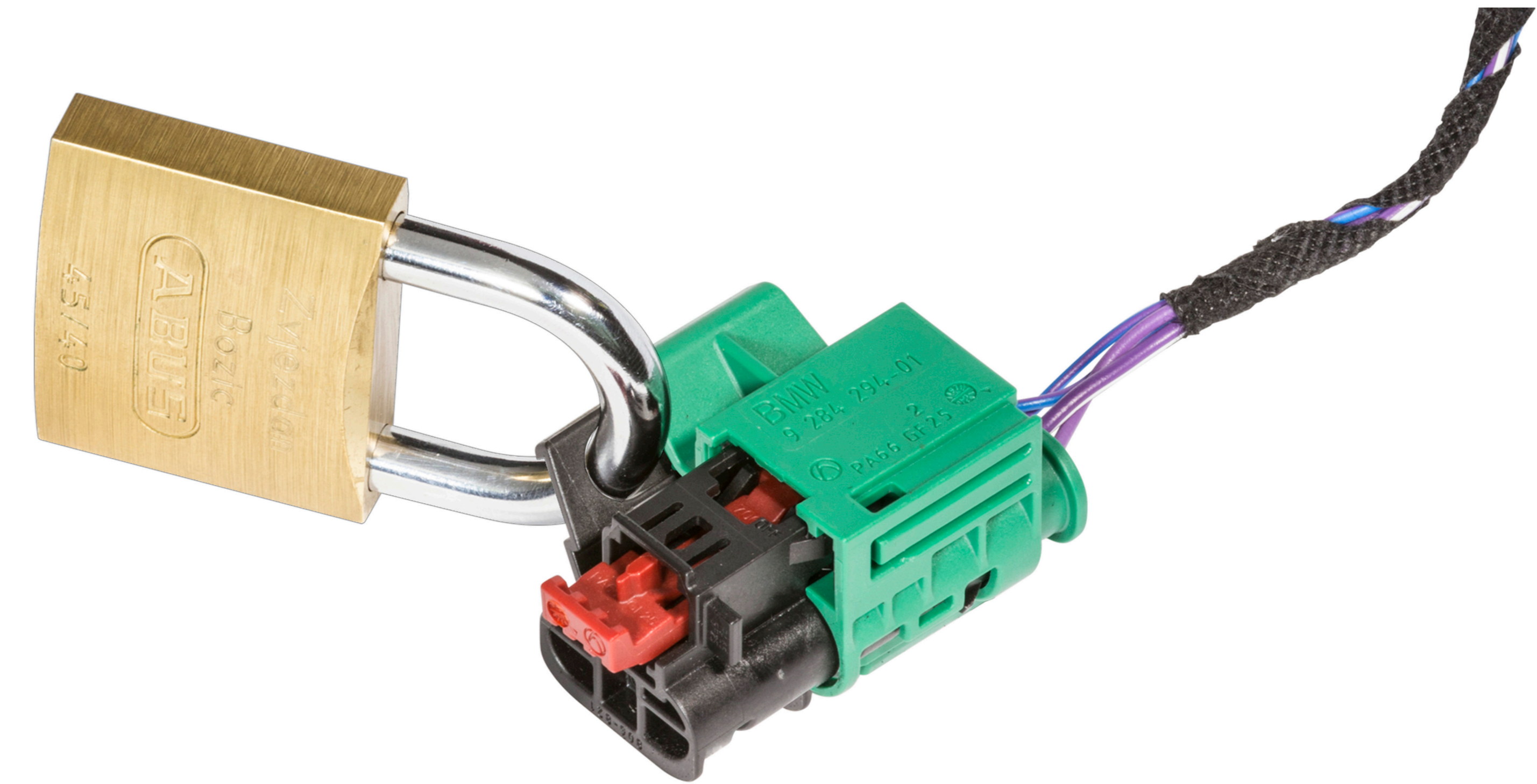

Gegen Wiedereinschalten sichern



Spannungsfreiheit feststellen

TECHNISCHE QUALIFIZIERUNG. GRUNDLAGEN HOCHVOLT-TECHNIK.

WARNHINWEISSCHILDER.

4

DEENERGISED



Do not connect any external voltage supply
Sign can only be removed by an
authorised person (qual. elec. / HV exp.)
or instructed person (elec. f. set tasks / HV tech.)

Name: _____ Tel.: _____

Date: _____ VIN: _____

Signature: _____

5

HIGH-VOLTAGE TEST OPERATION



**Access only after consultation
with the acting supervisor**

Name: _____ Tel.: _____

Date: _____ VIN: _____

6

HIGH-VOLTAGE WARNING

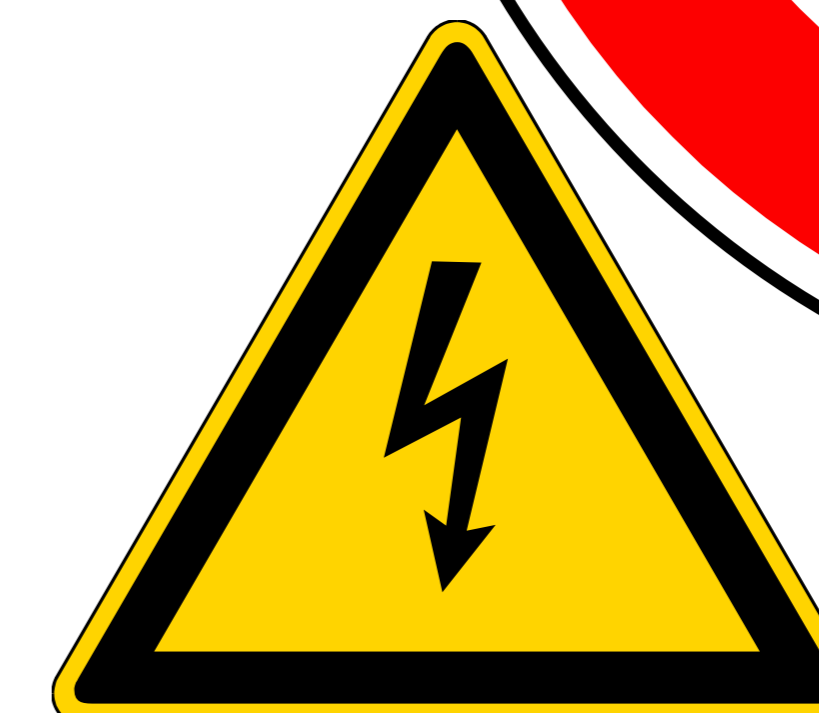

**Access only after consultation with the acting
supervisor (qual. elec. / HV exp.)!
Warning about electrical voltage!**

Name of qual. elec./HV exp.: _____

Tel.: _____

Date: _____ VIN: _____

TECHNISCHE QUALIFIZIERUNG. GRUNDLAGEN HOCHVOLT-TECHNIK.

FULL HYBRID-FAHRZEUG.

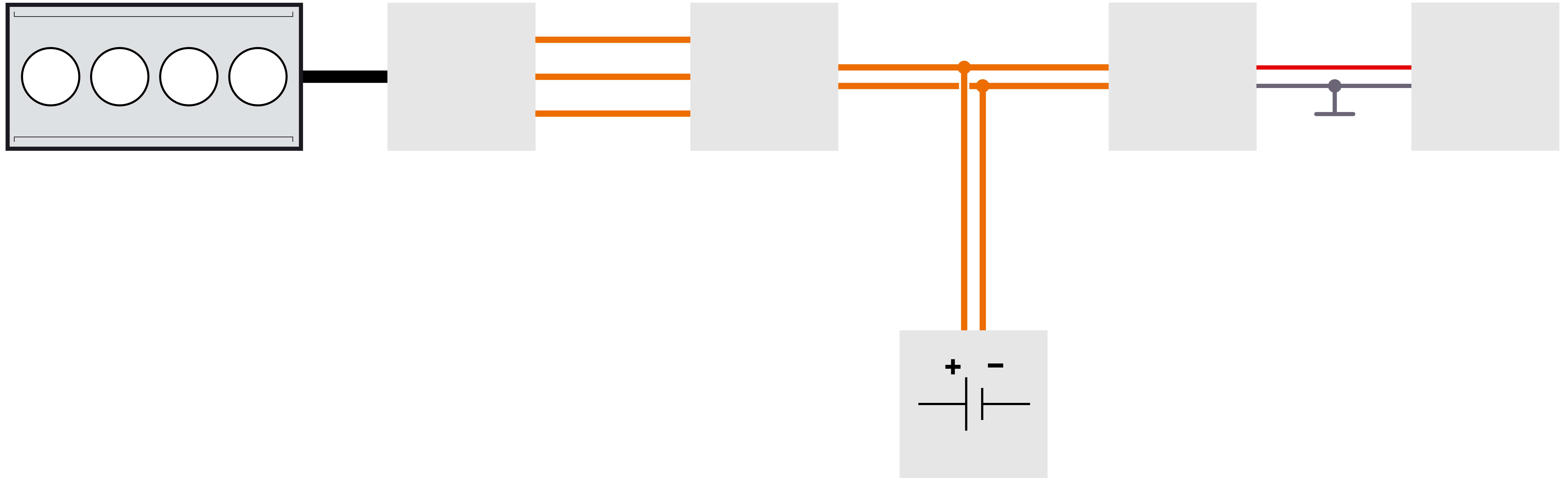



AC

DC

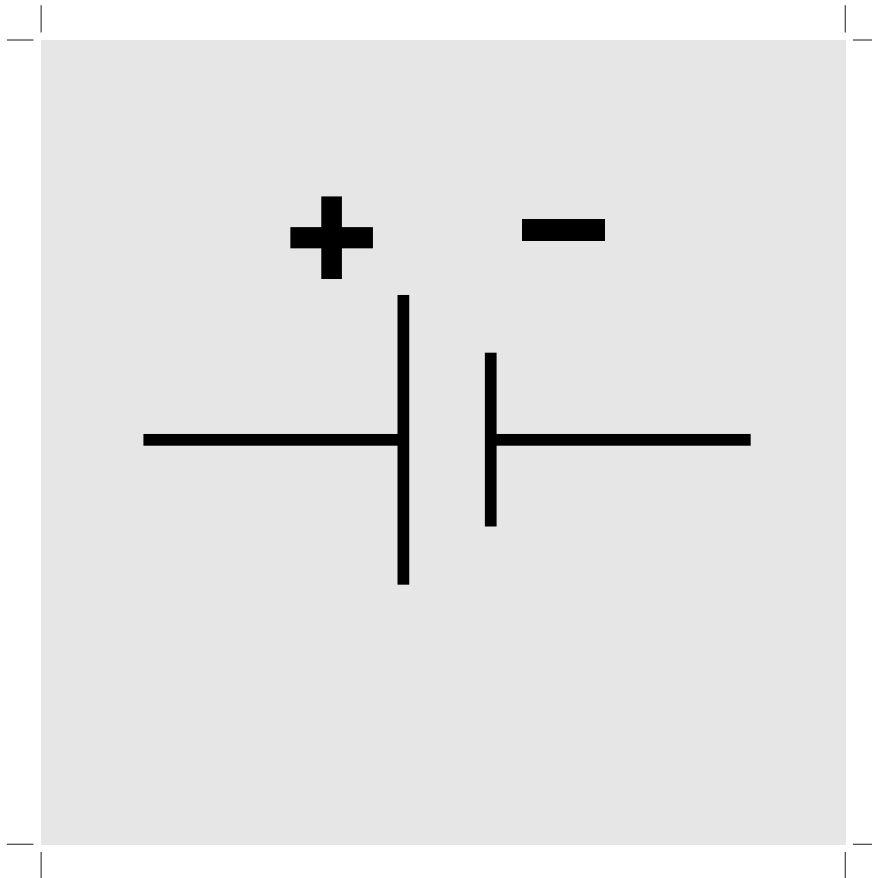
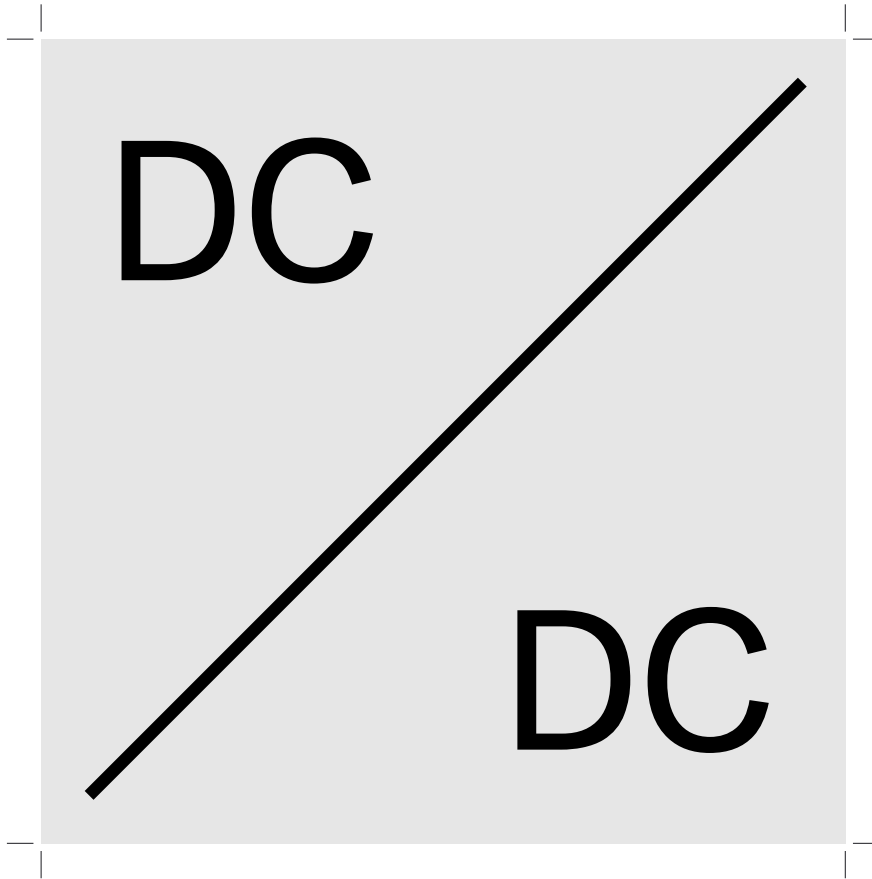

TECHNISCHE QUALIFIZIERUNG. GRUNDLAGEN HOCHVOLT-TECHNIK.

FULL PLUG-IN-HYBRID-FAHRZEUG.

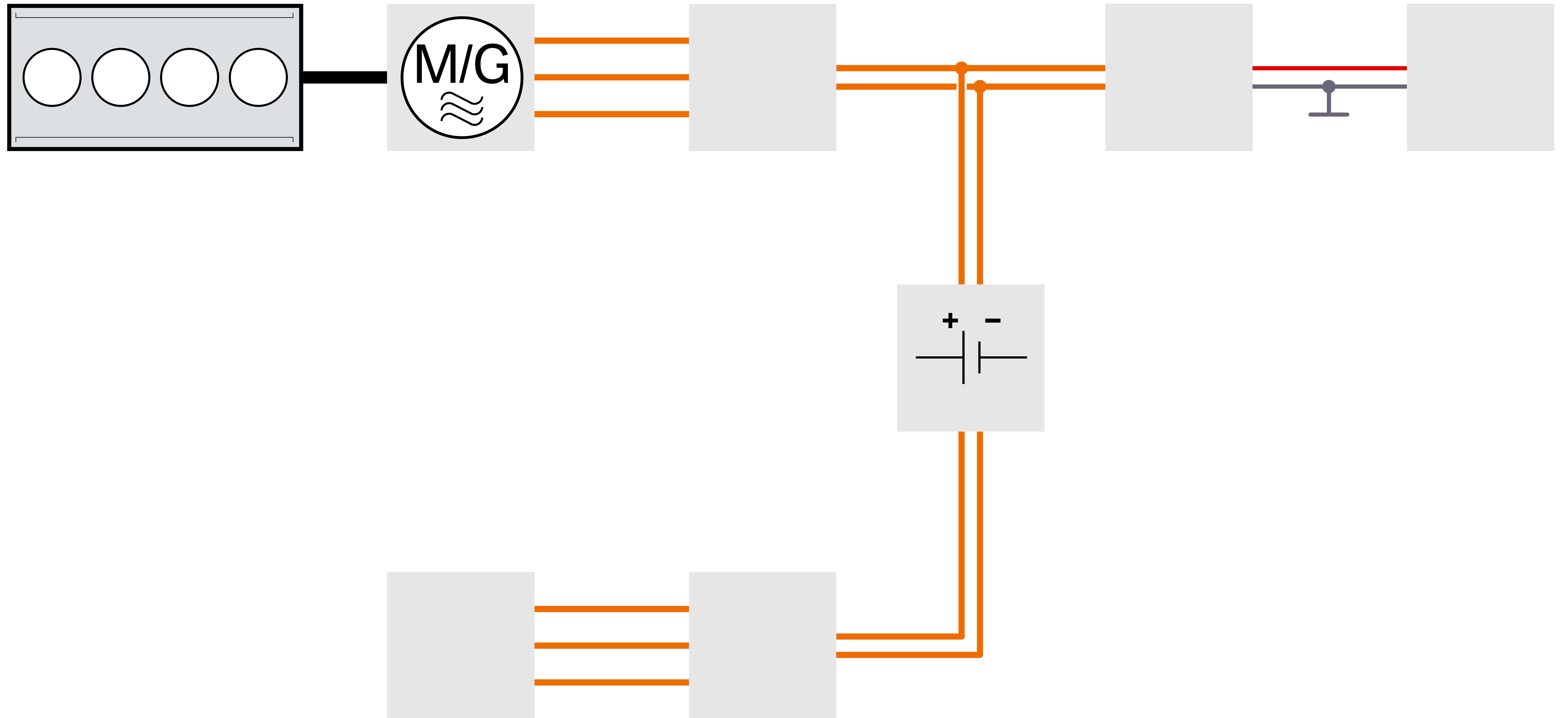

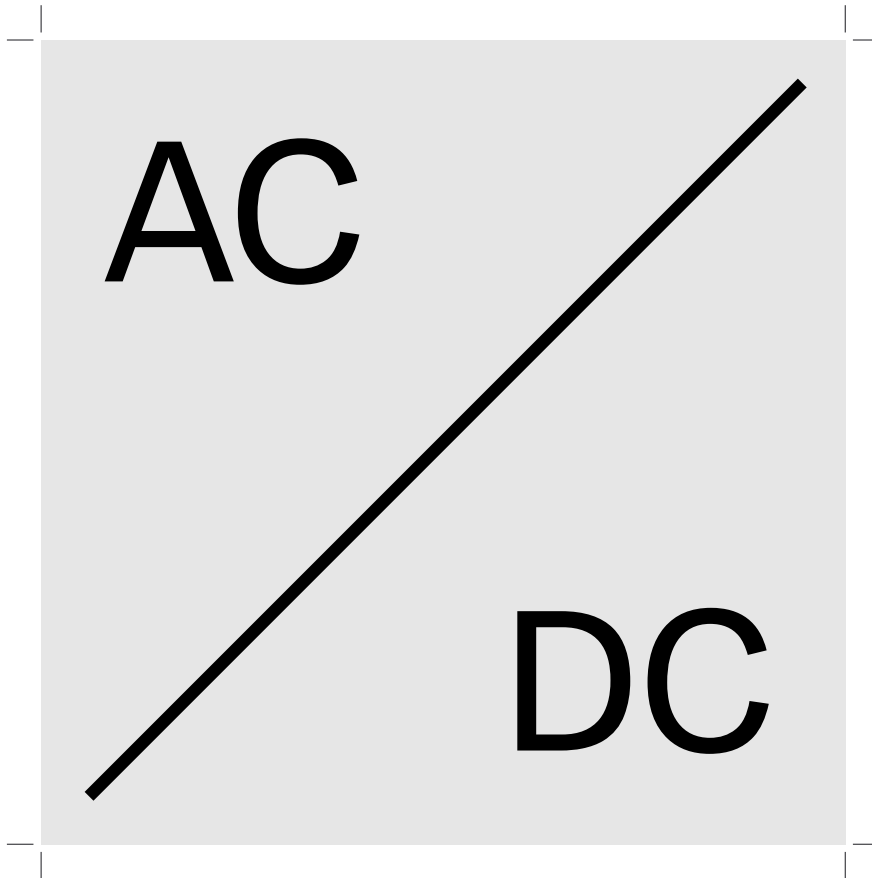
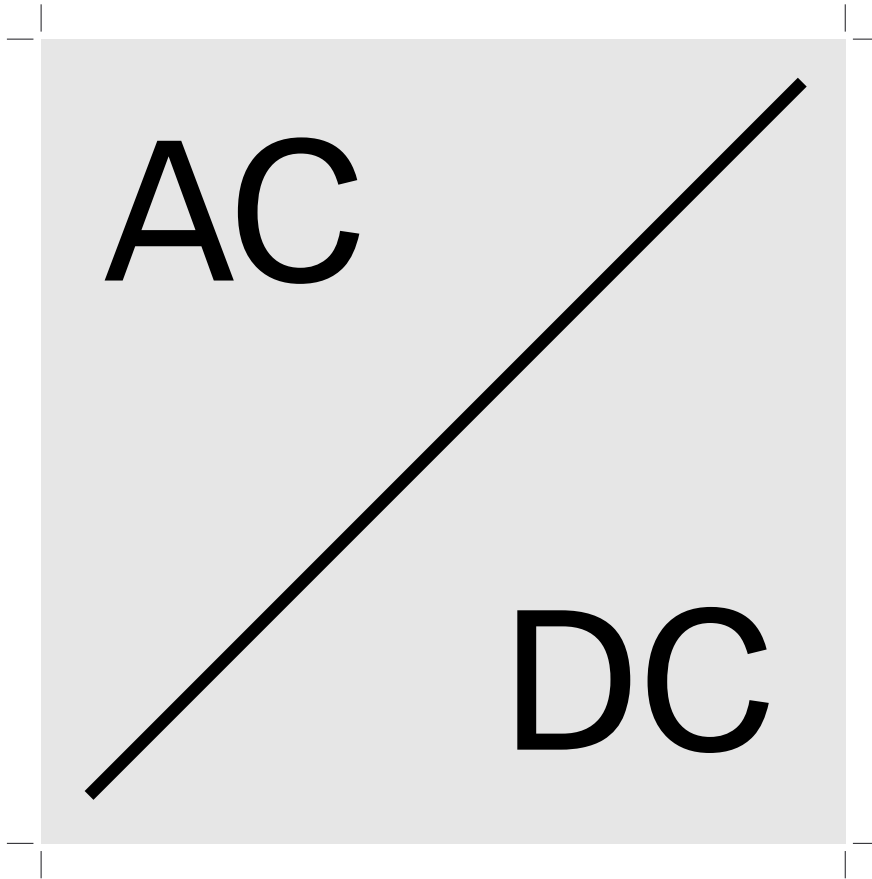

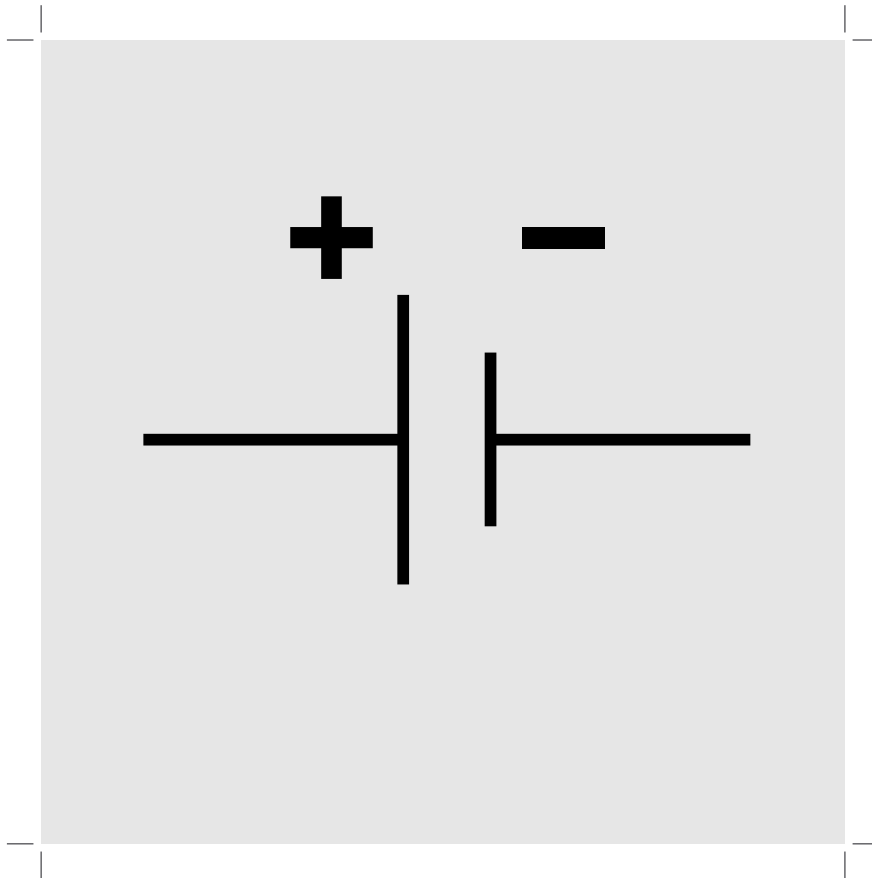
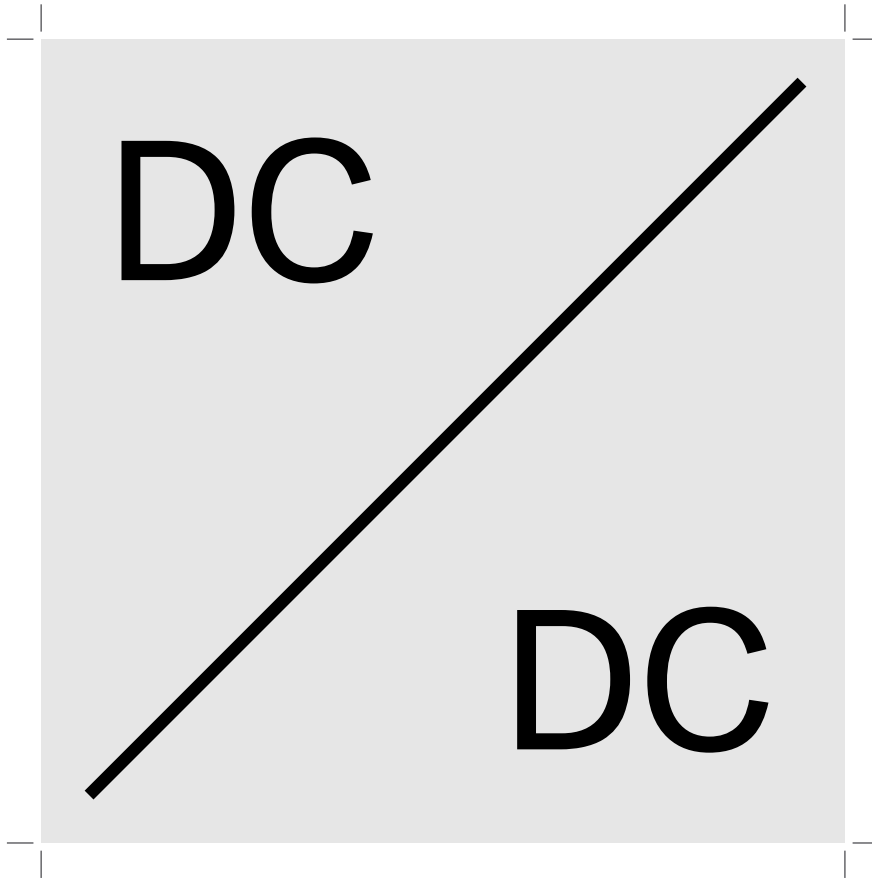

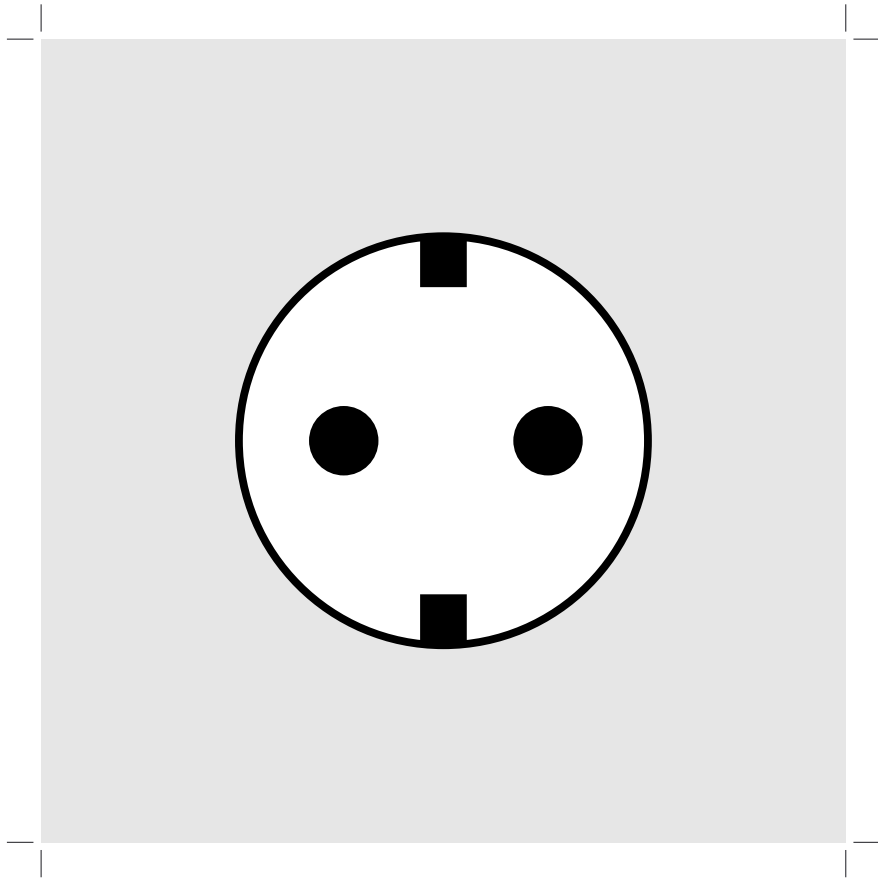

TECHNISCHE QUALIFIZIERUNG. GRUNDLAGEN HOCHVOLT-TECHNIK.

ACHSPARALLELES PLUG-IN-HYBRID-FAHRZEUG.

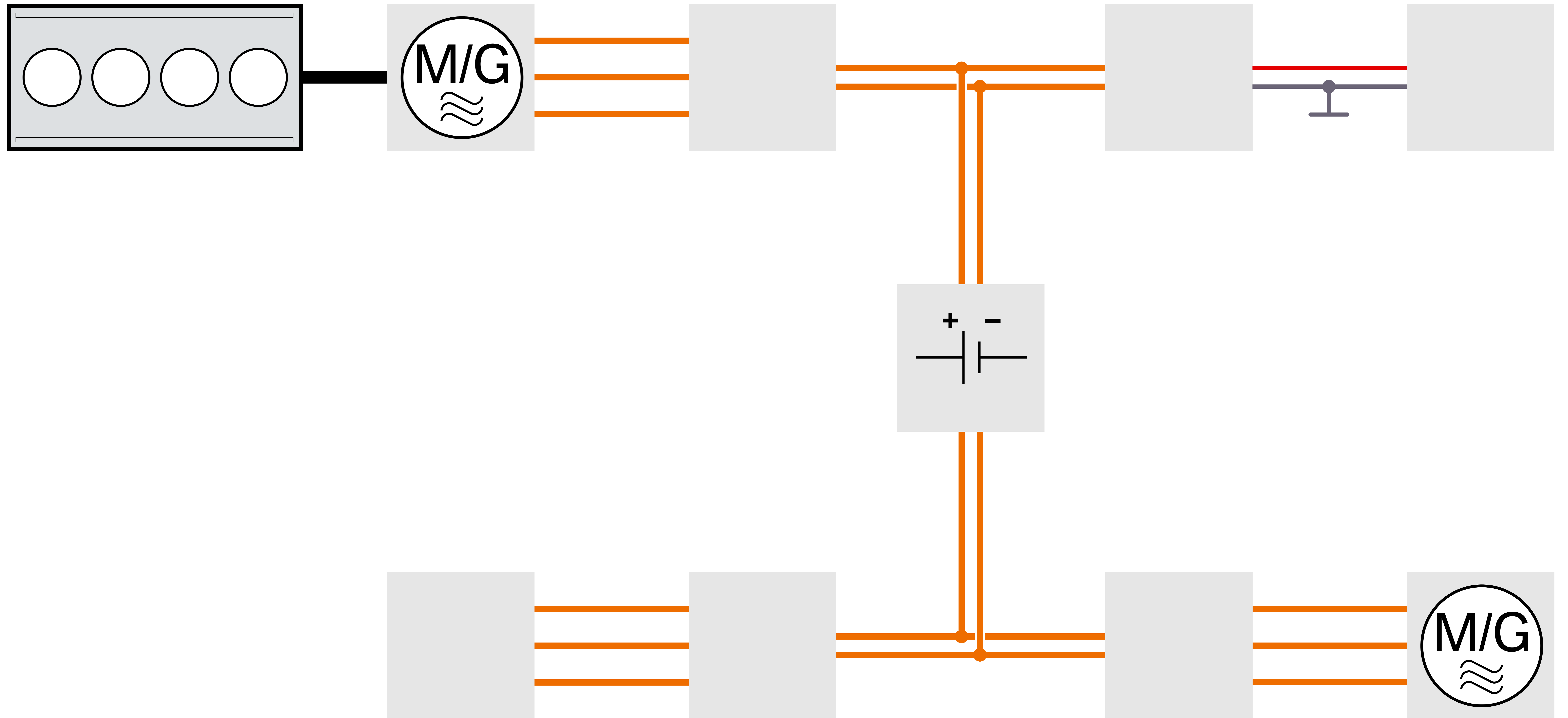

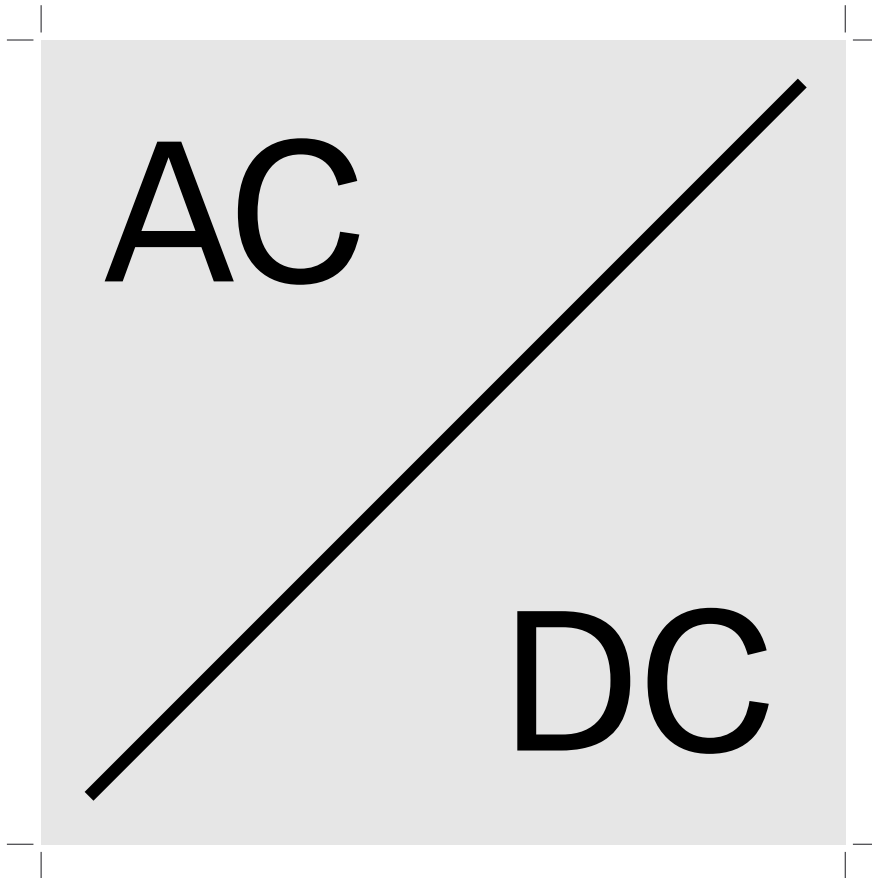
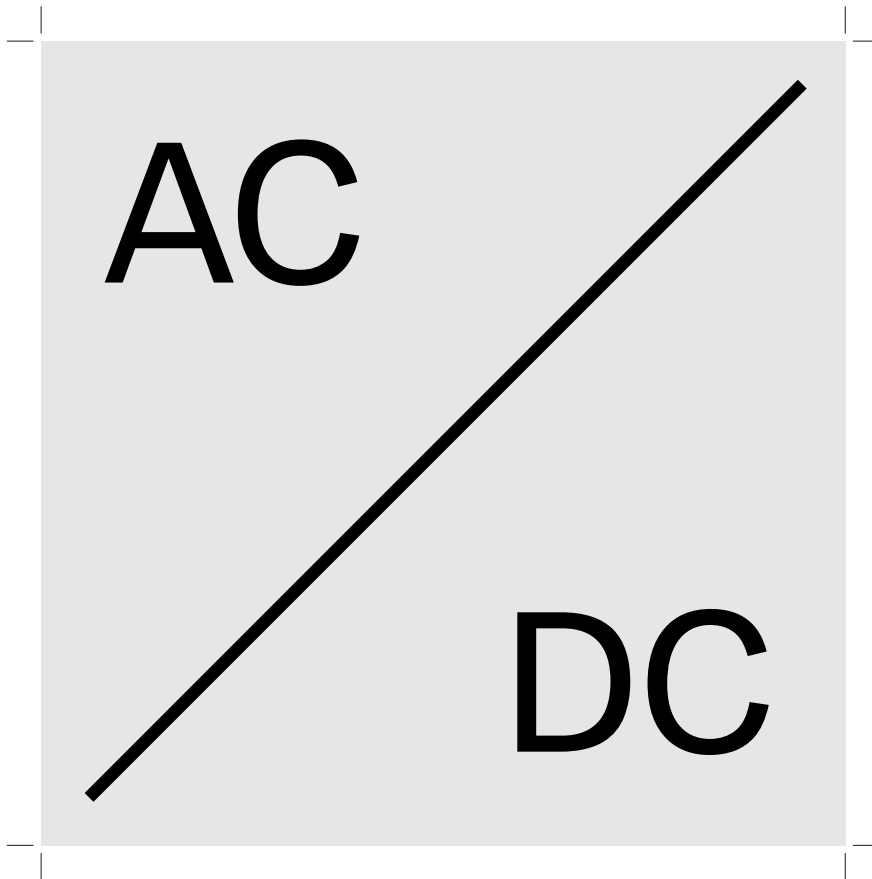

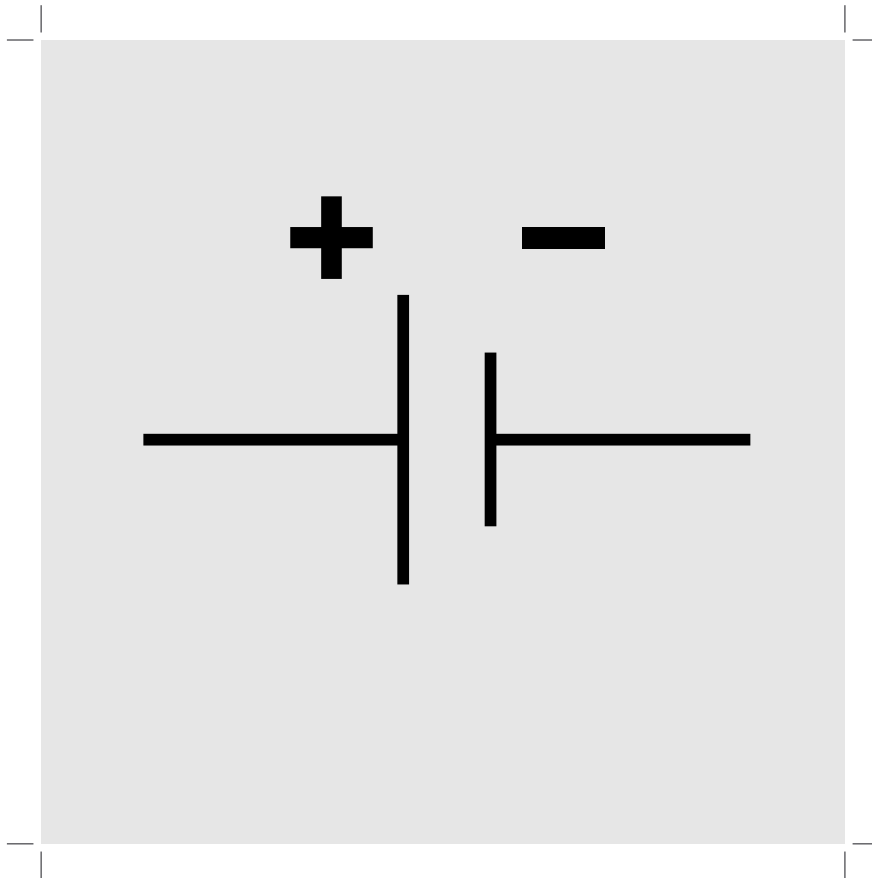
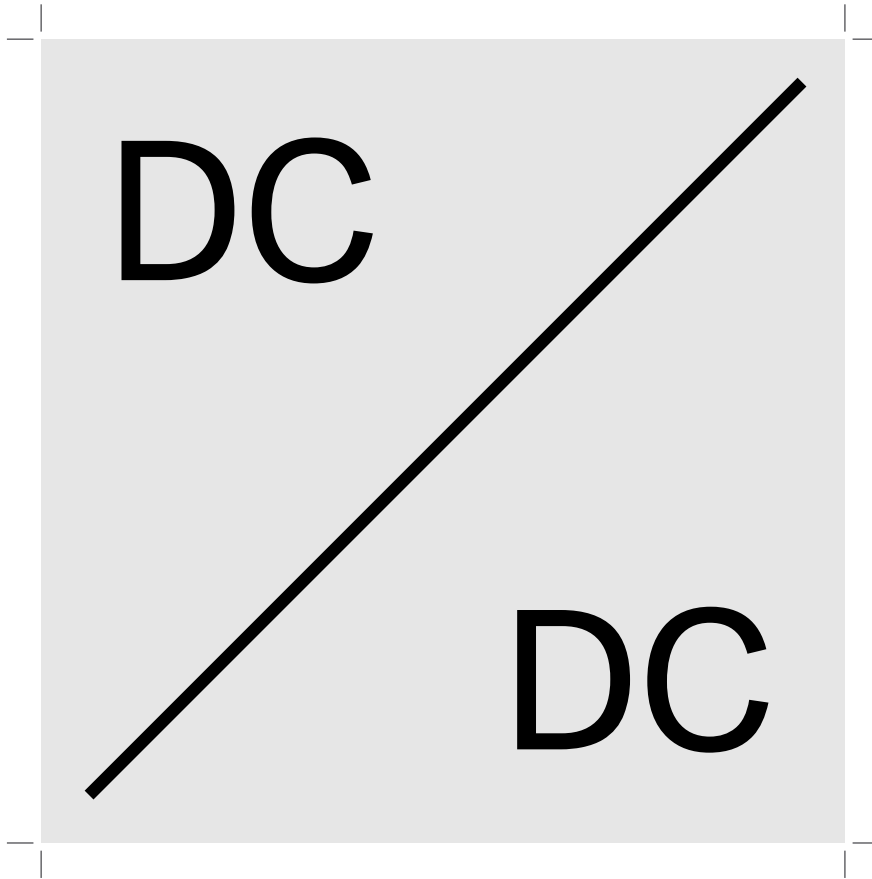

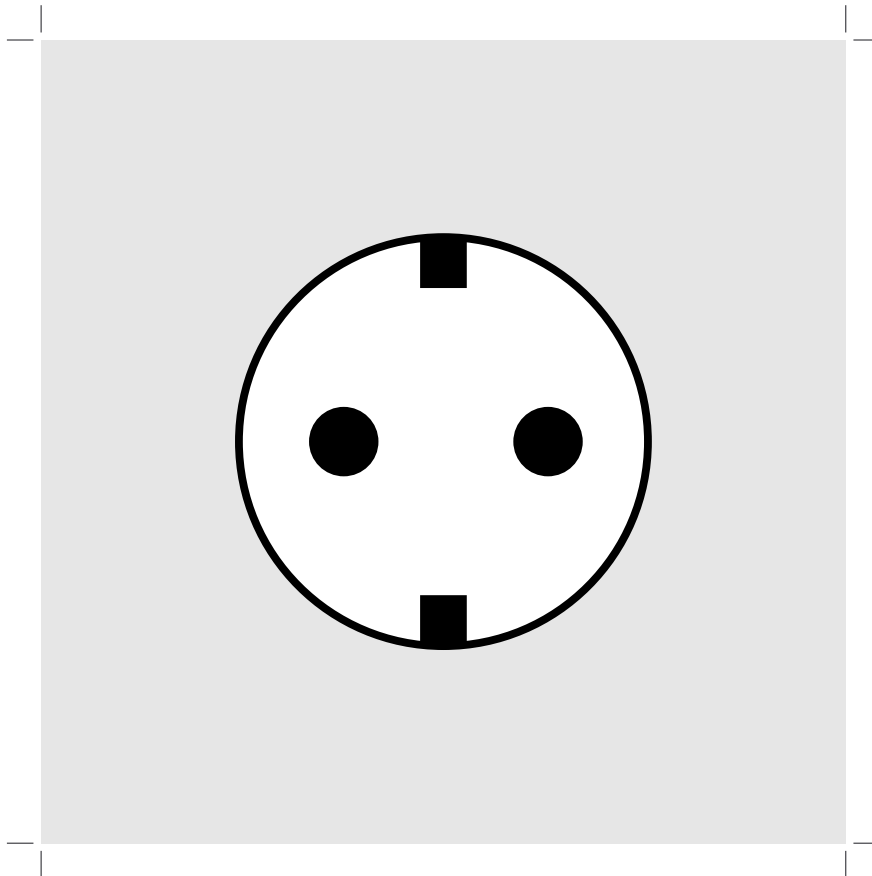
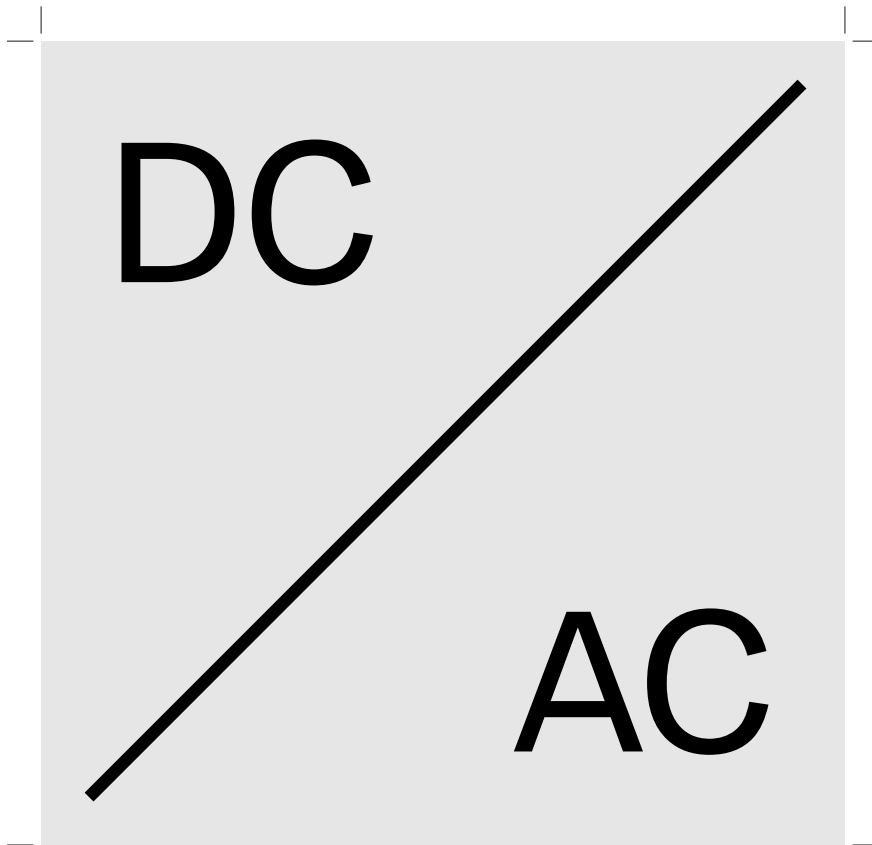

TECHNISCHE QUALIFIZIERUNG. GRUNDLAGEN HOCHVOLT-TECHNIK.

SERIELLER HYBRID-ANTRIEB.

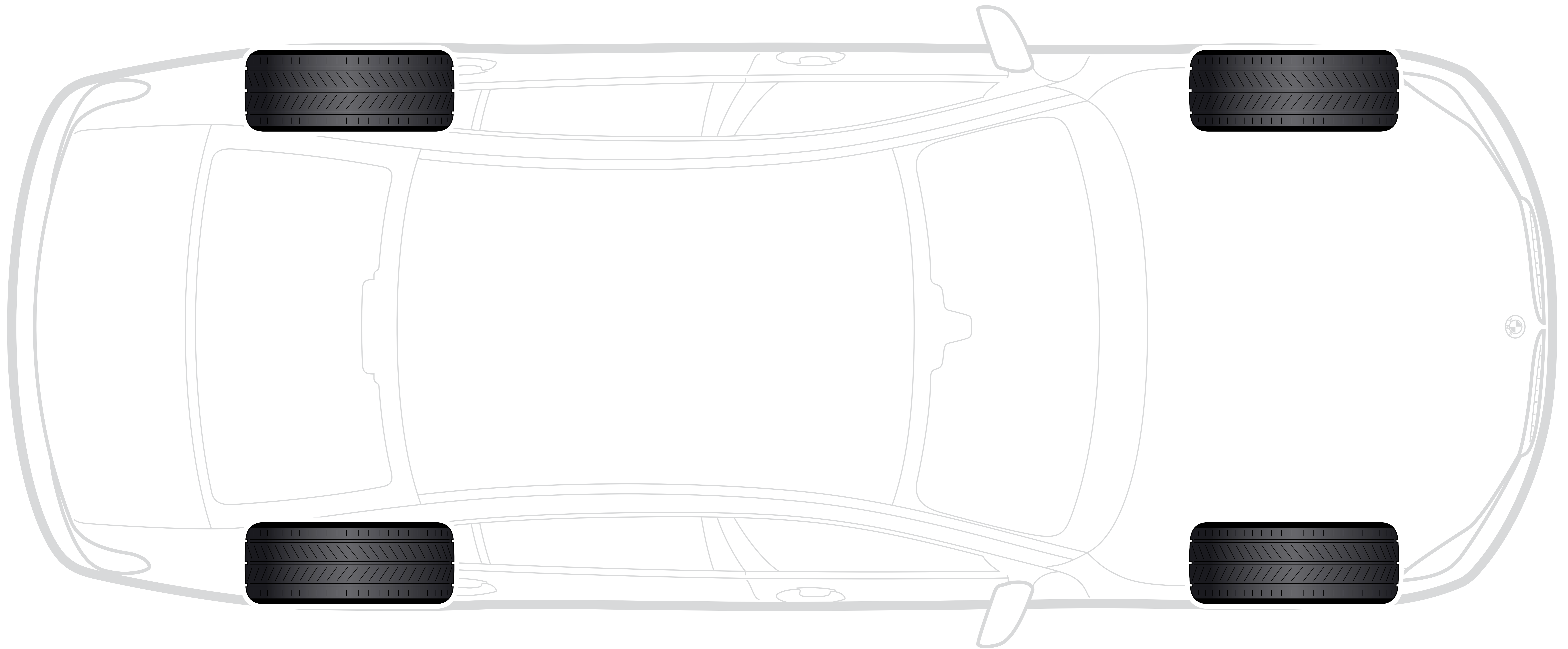

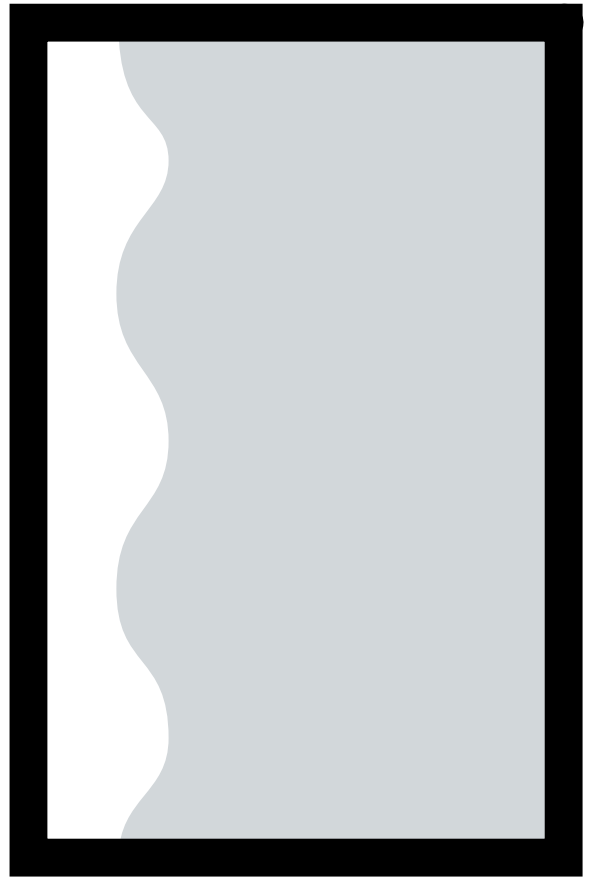
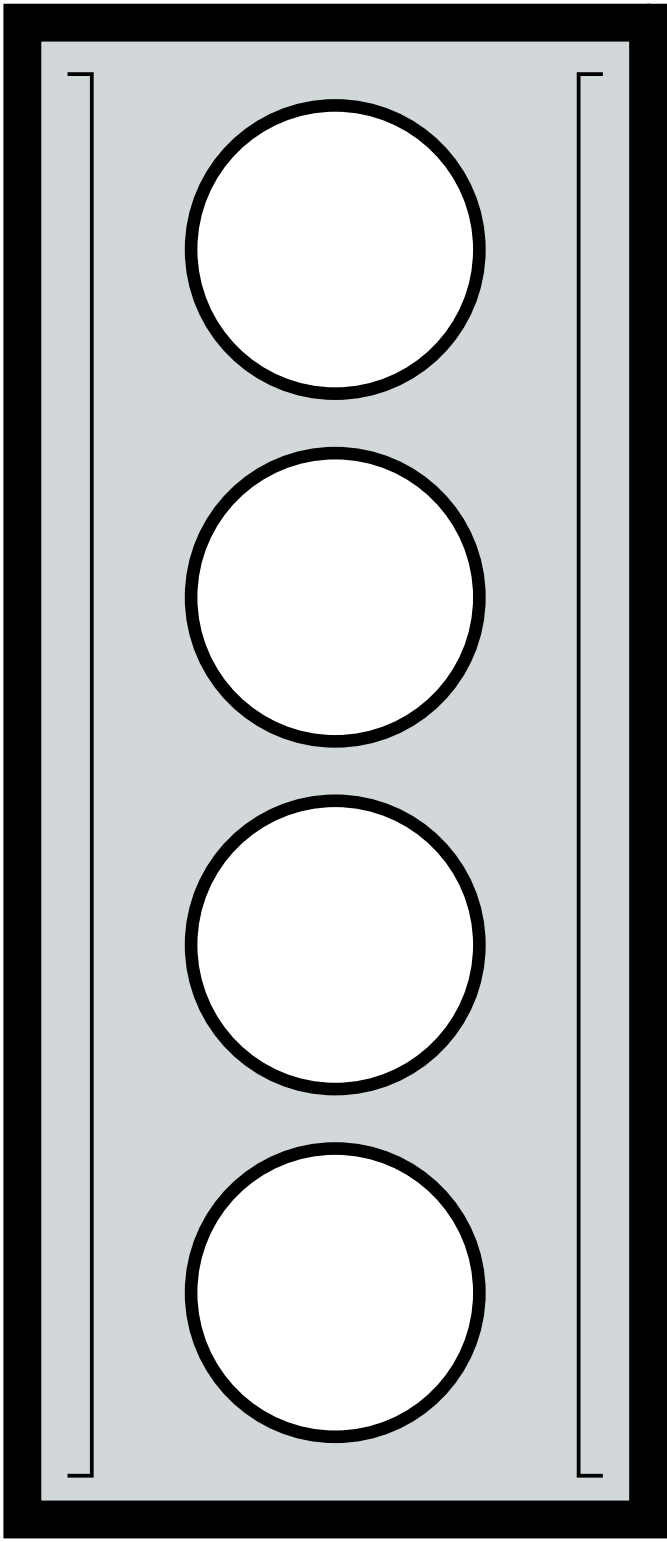

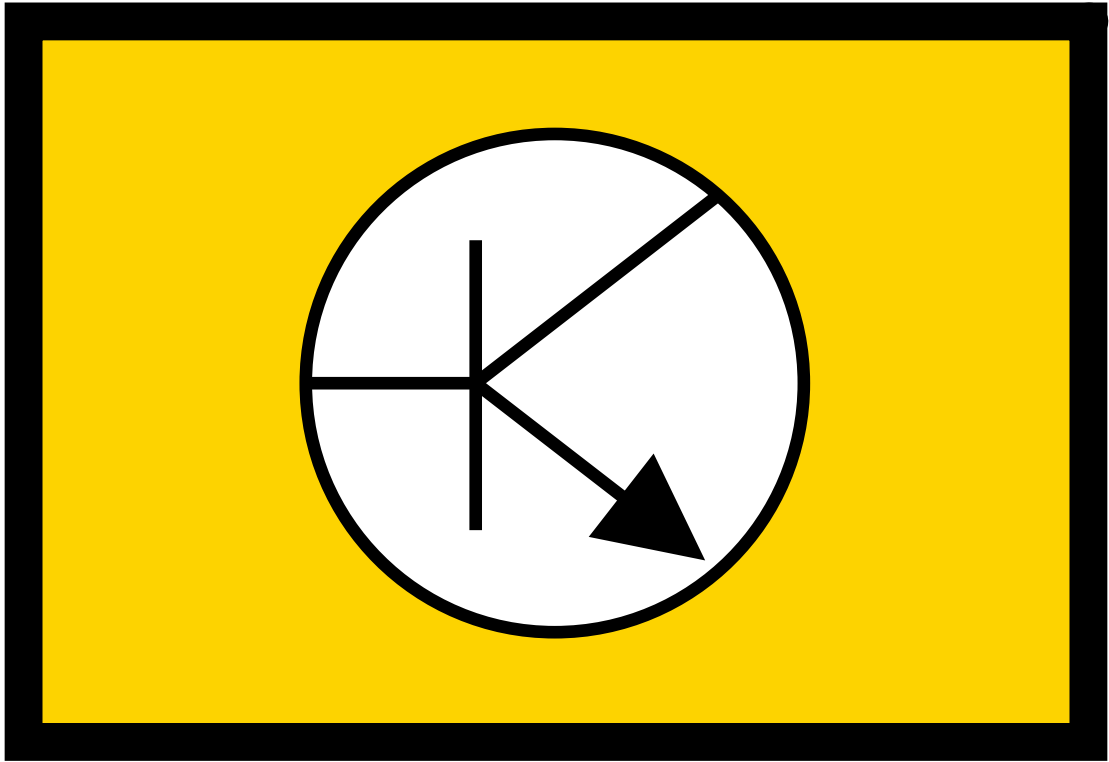

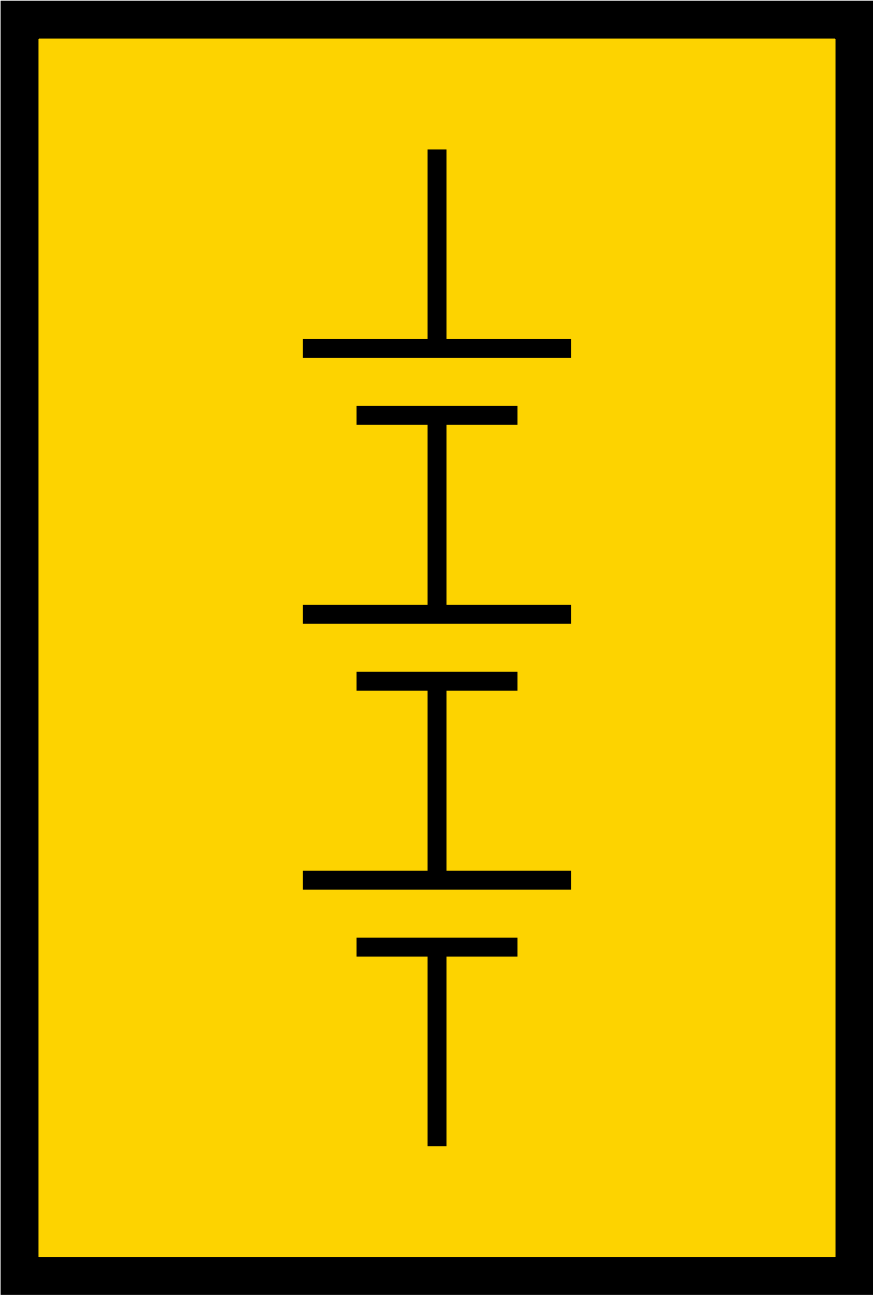

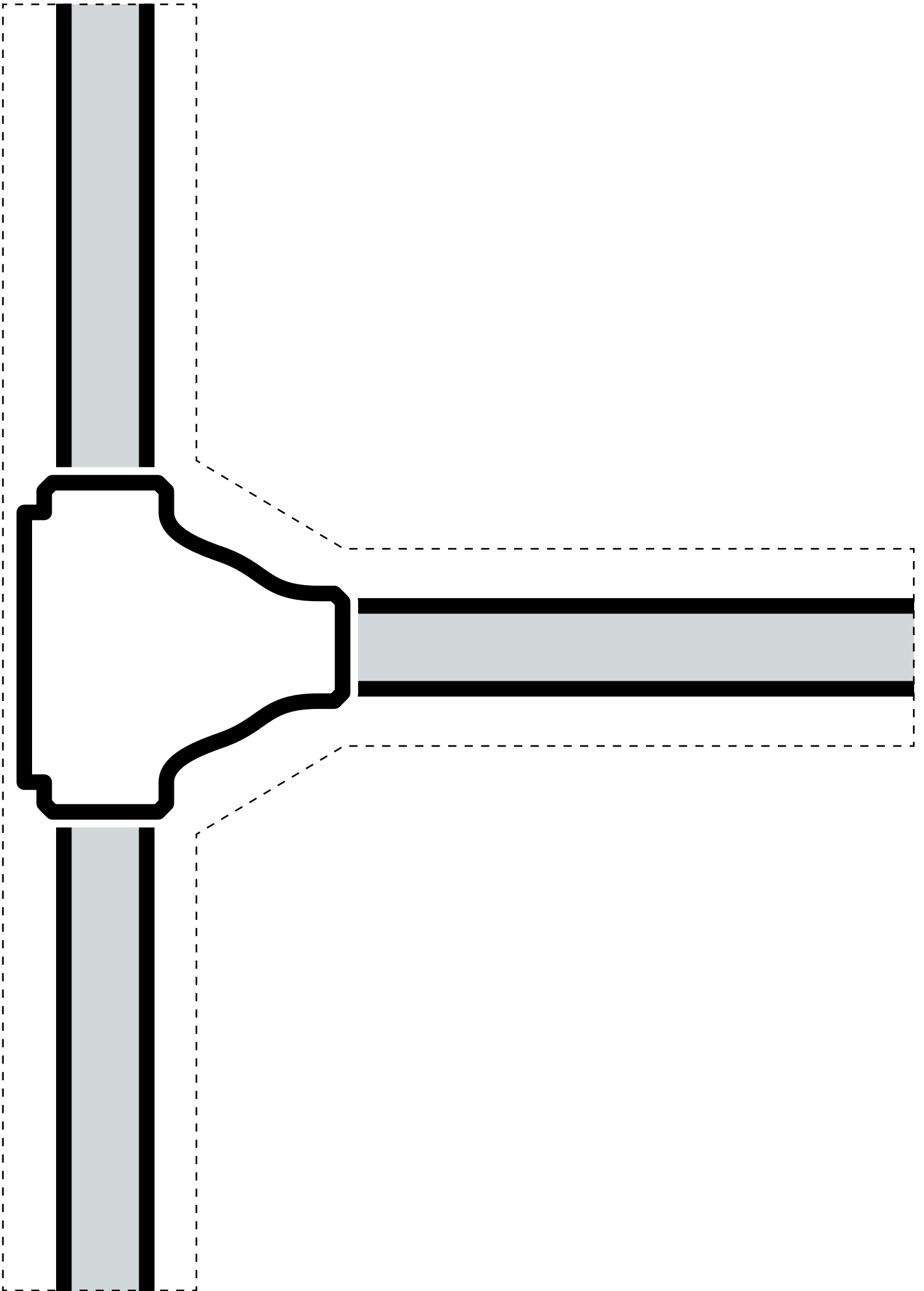

TECHNISCHE QUALIFIZIERUNG. GRUNDLAGEN HOCHVOLT-TECHNIK.

PARALLELER HYBRID-ANTRIEB.

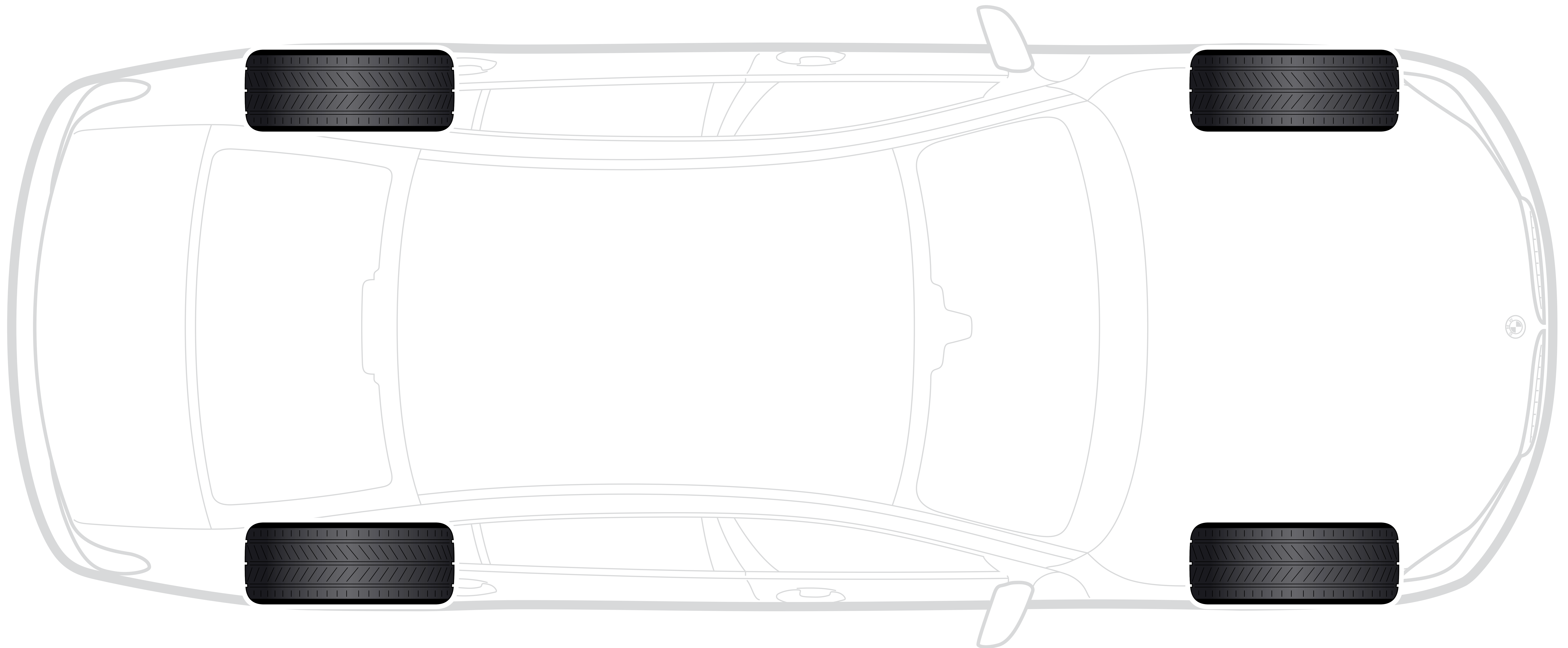

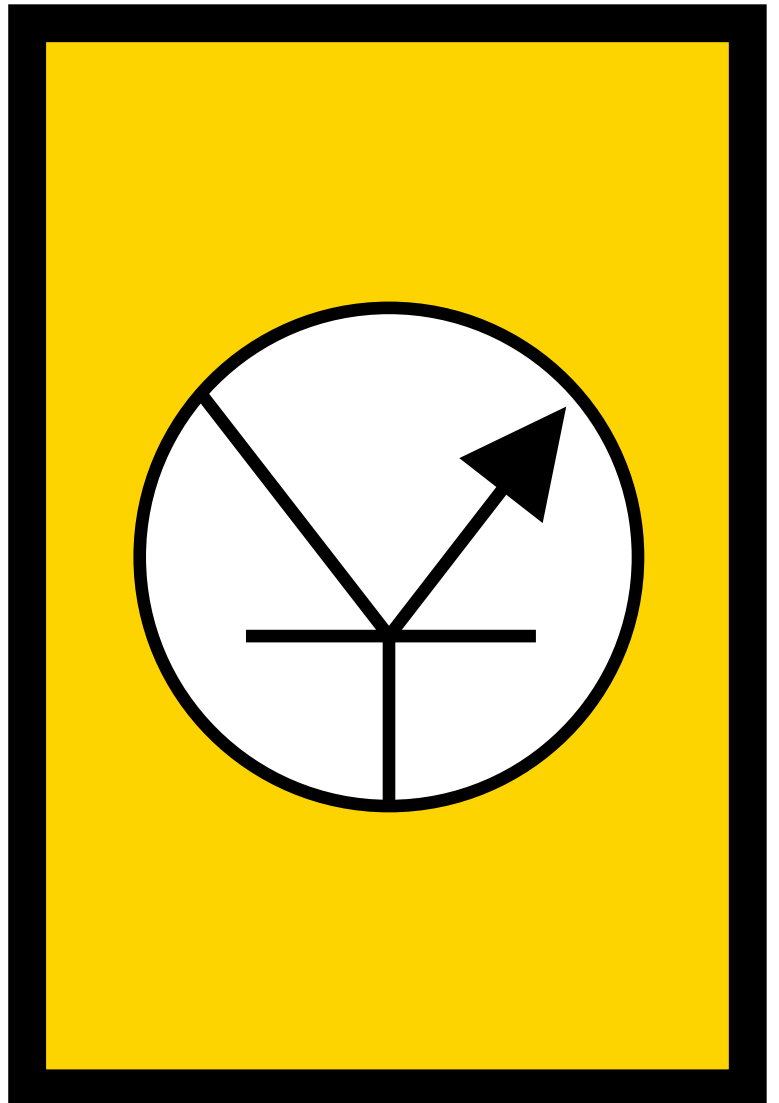
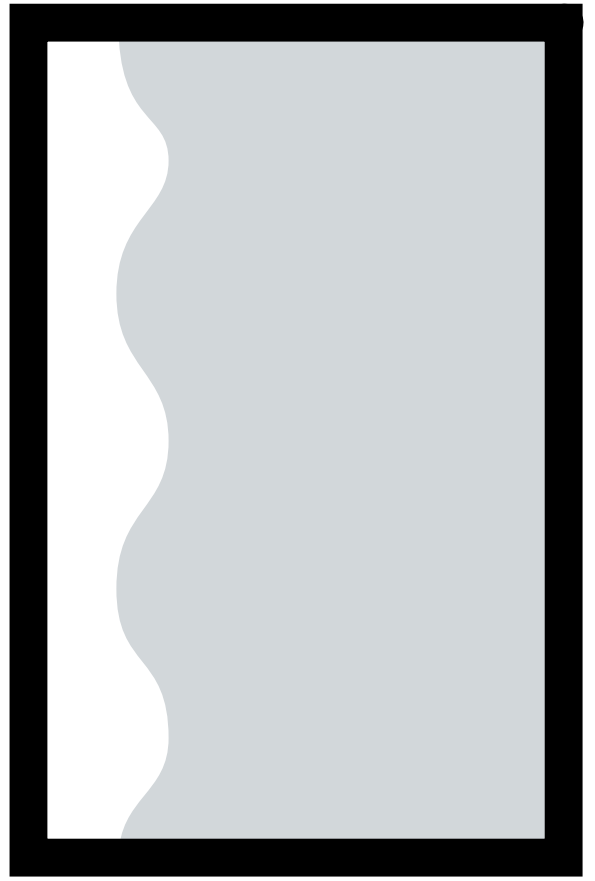
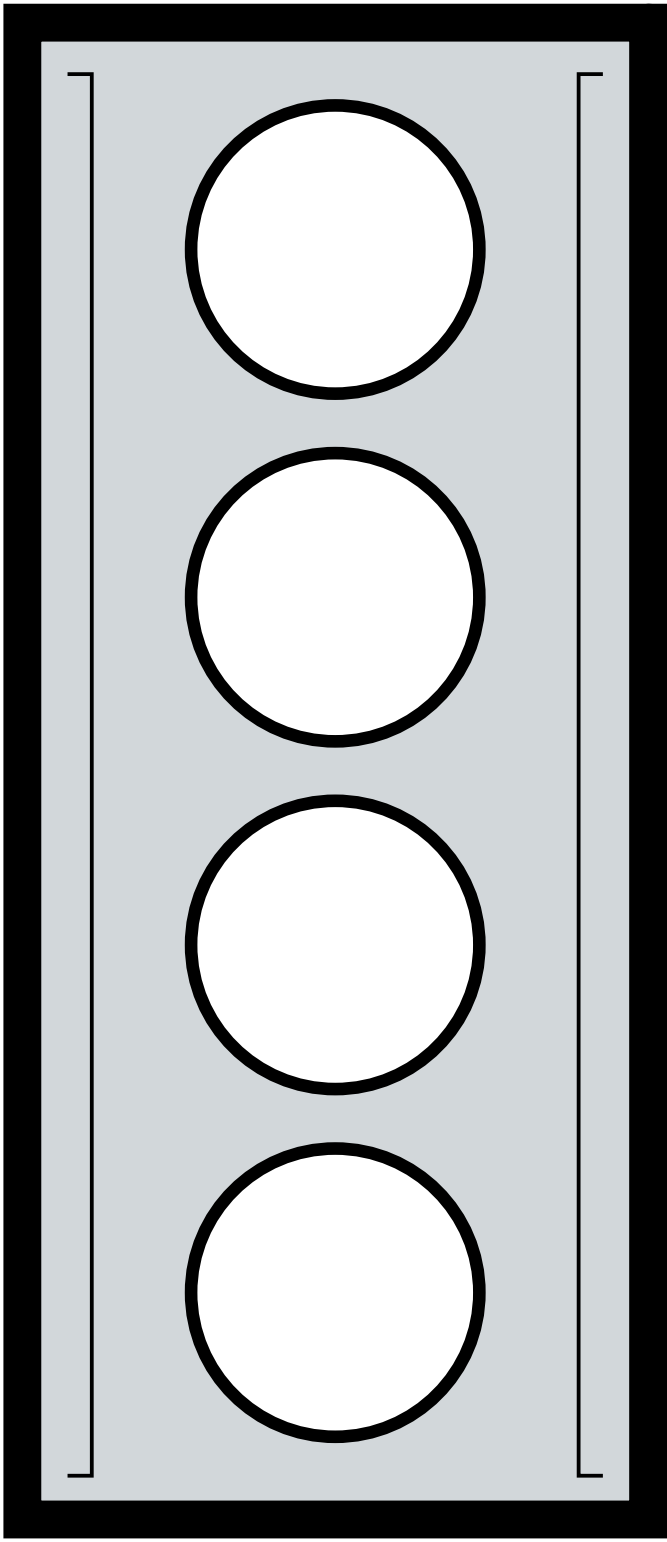

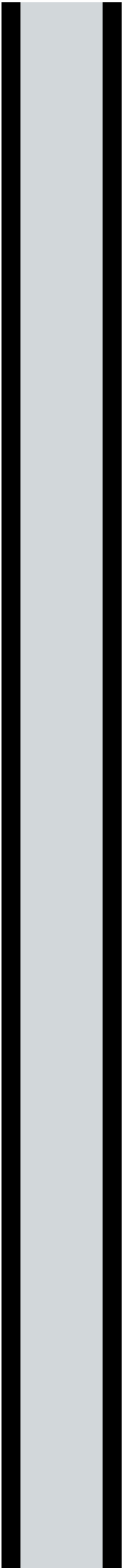
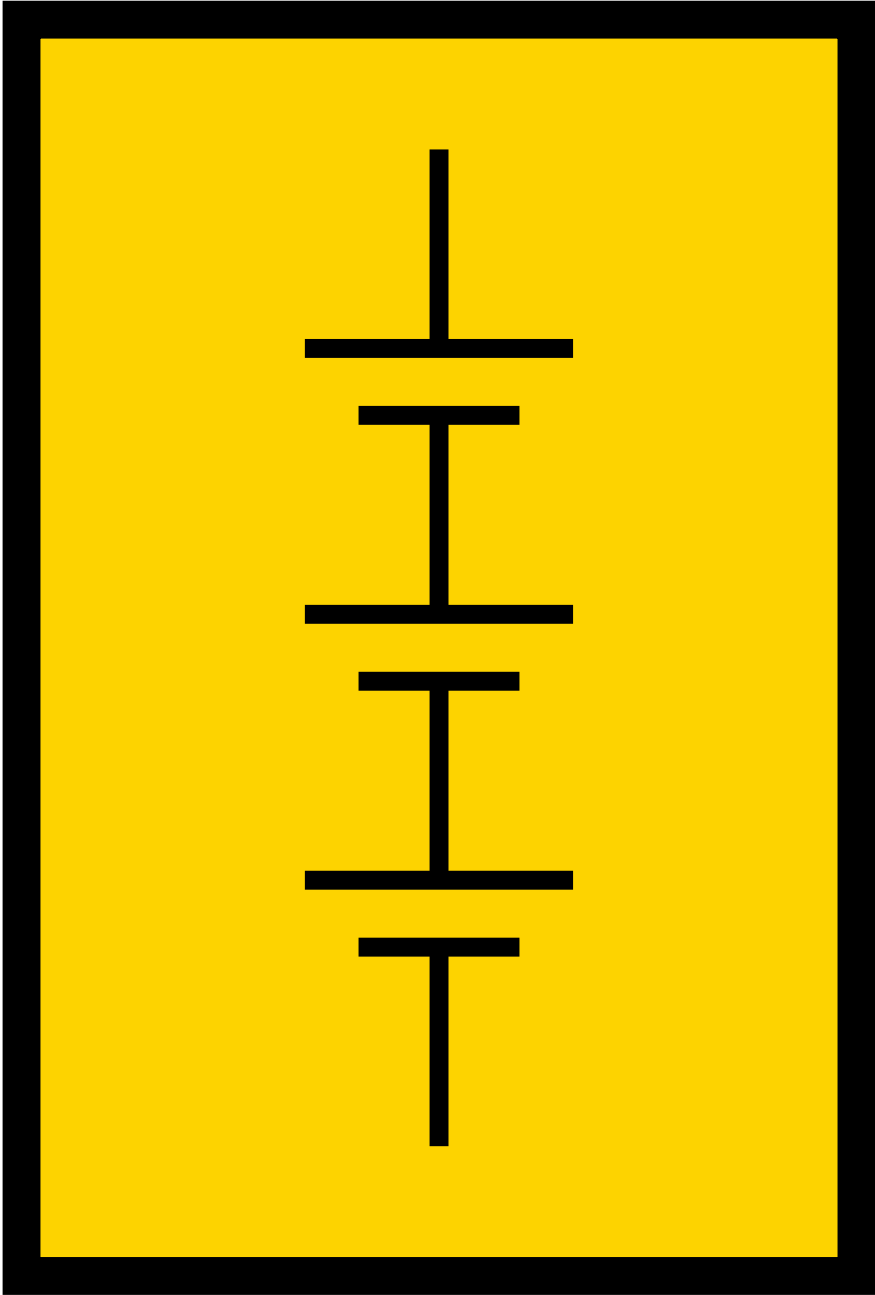
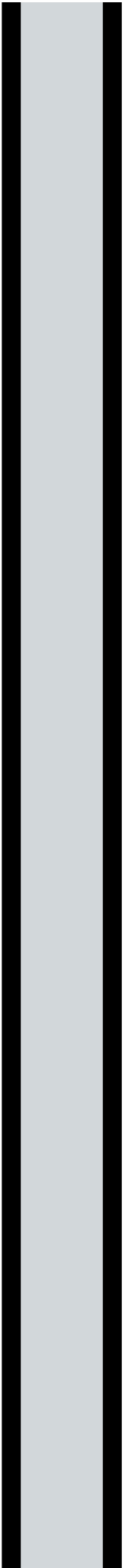

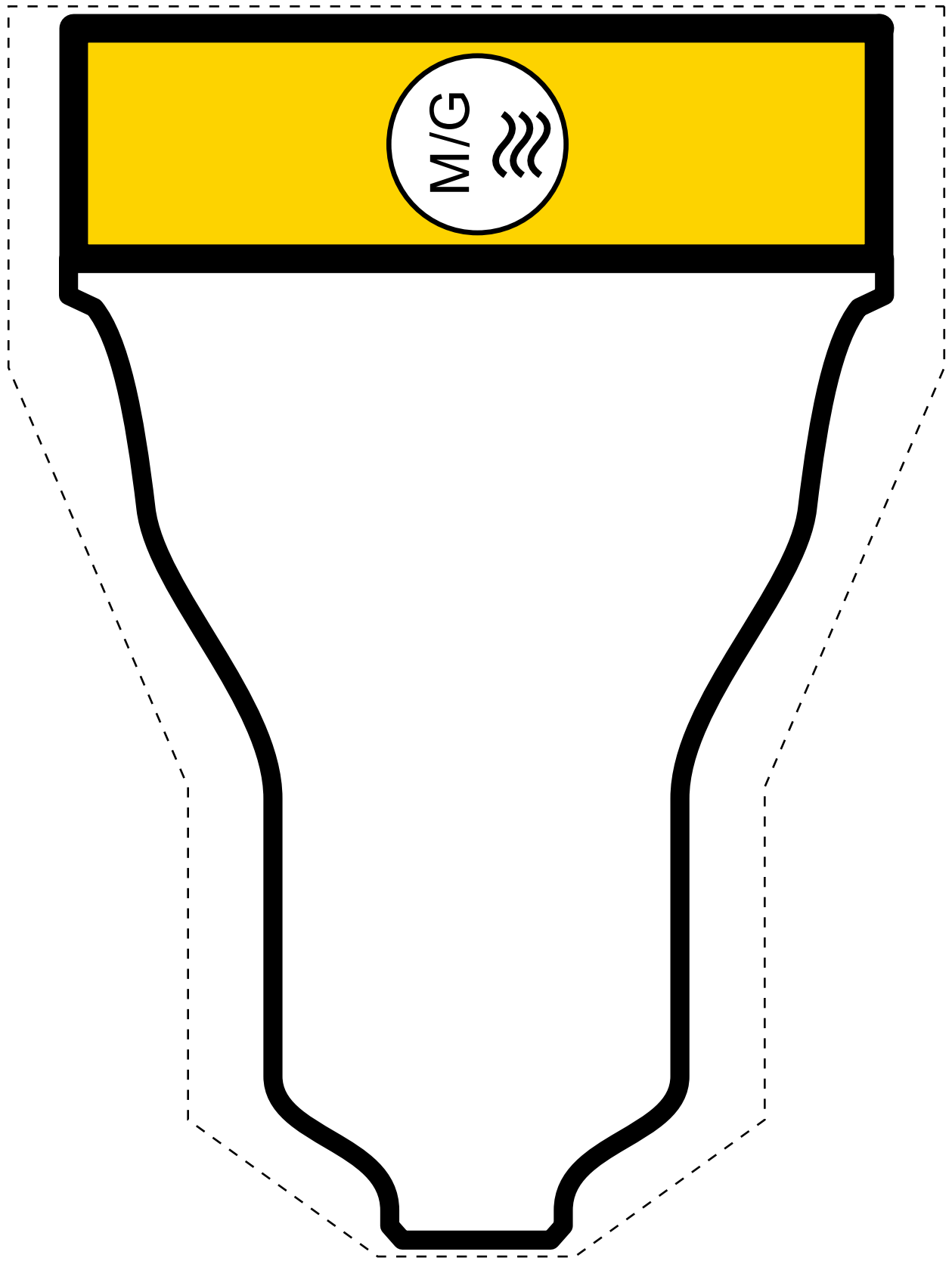

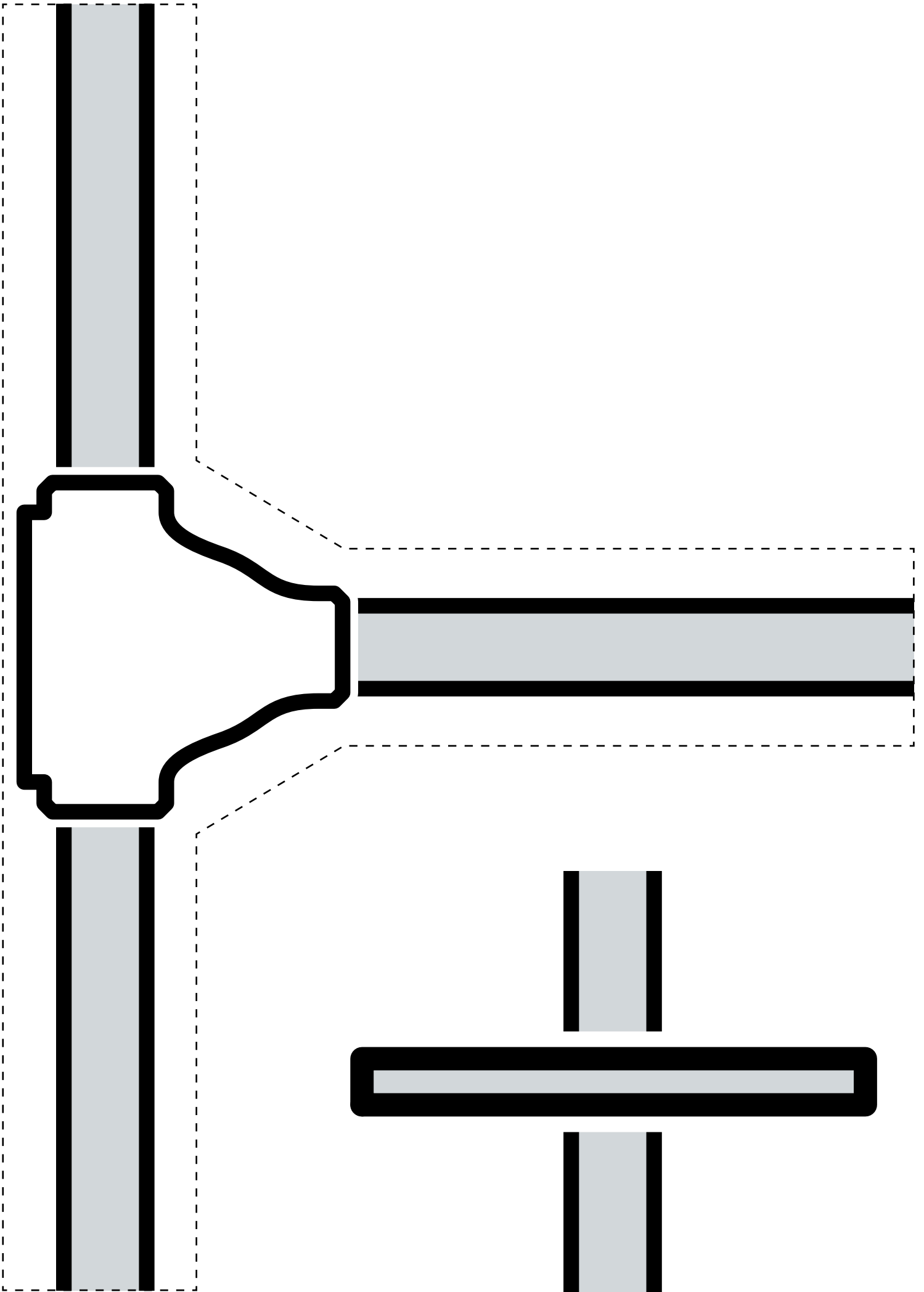

TECHNISCHE QUALIFIZIERUNG. GRUNDLAGEN HOCHVOLT-TECHNIK.

ACHSPARALLELER HYBRID-ANTRIEB.

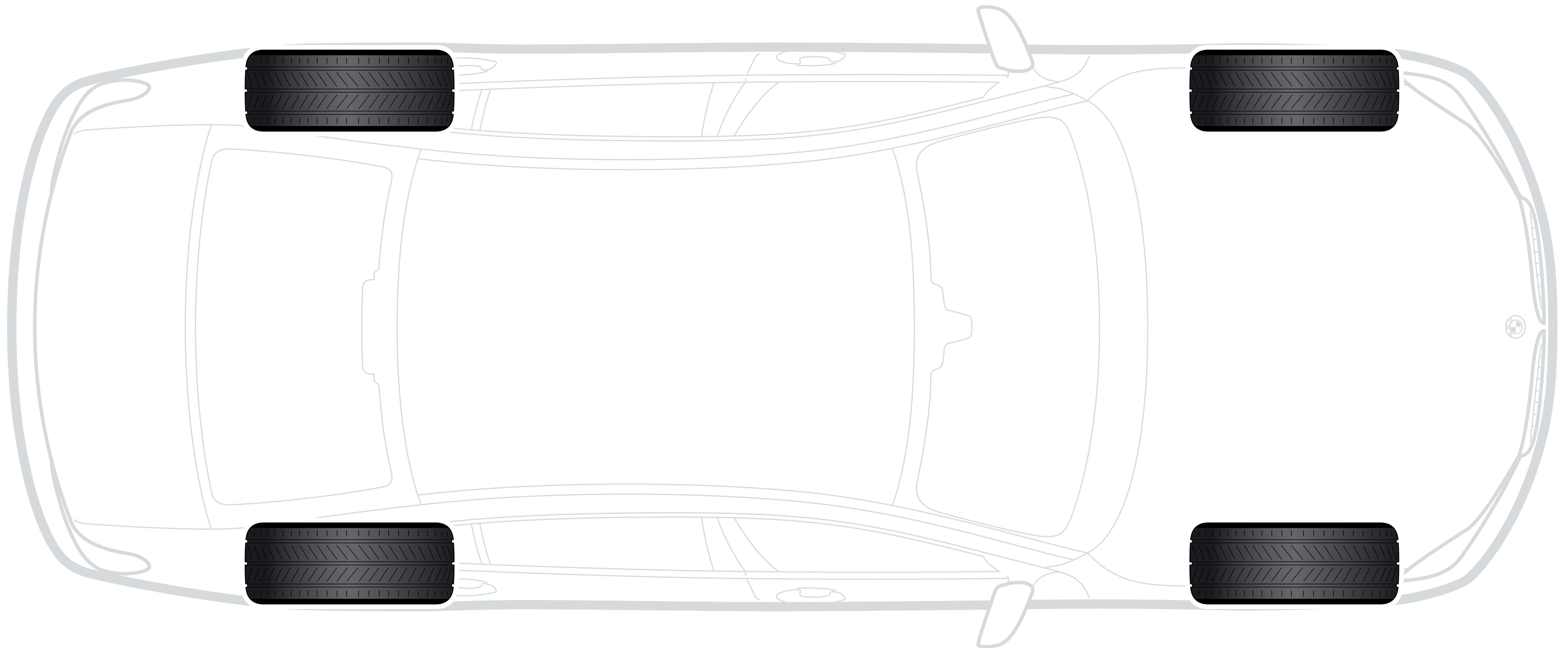

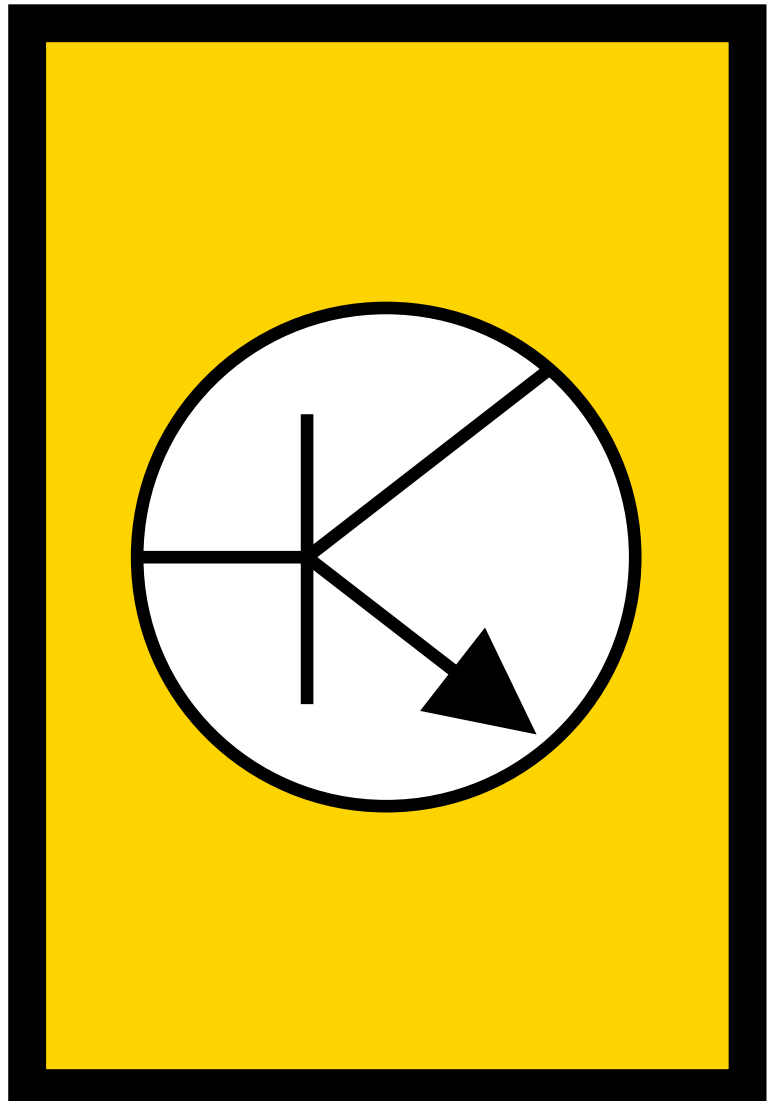
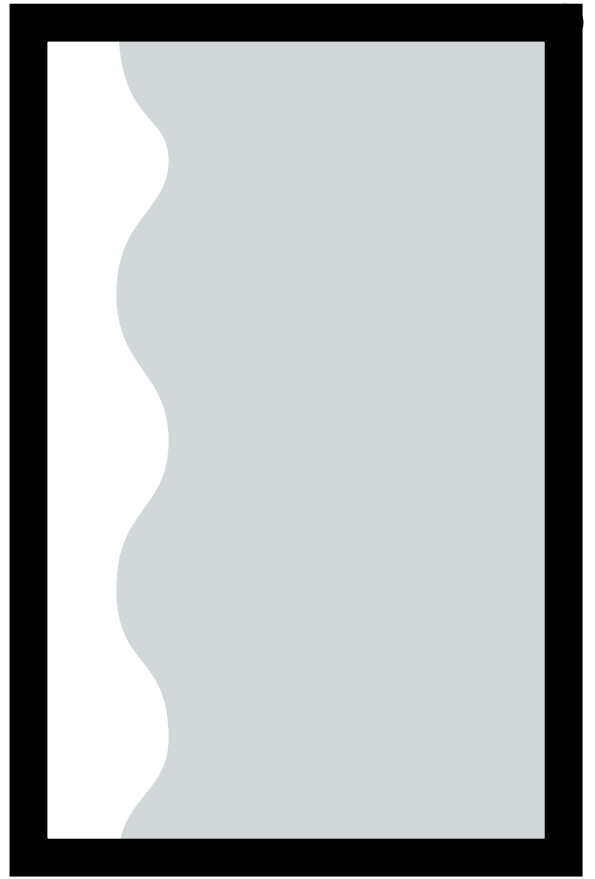
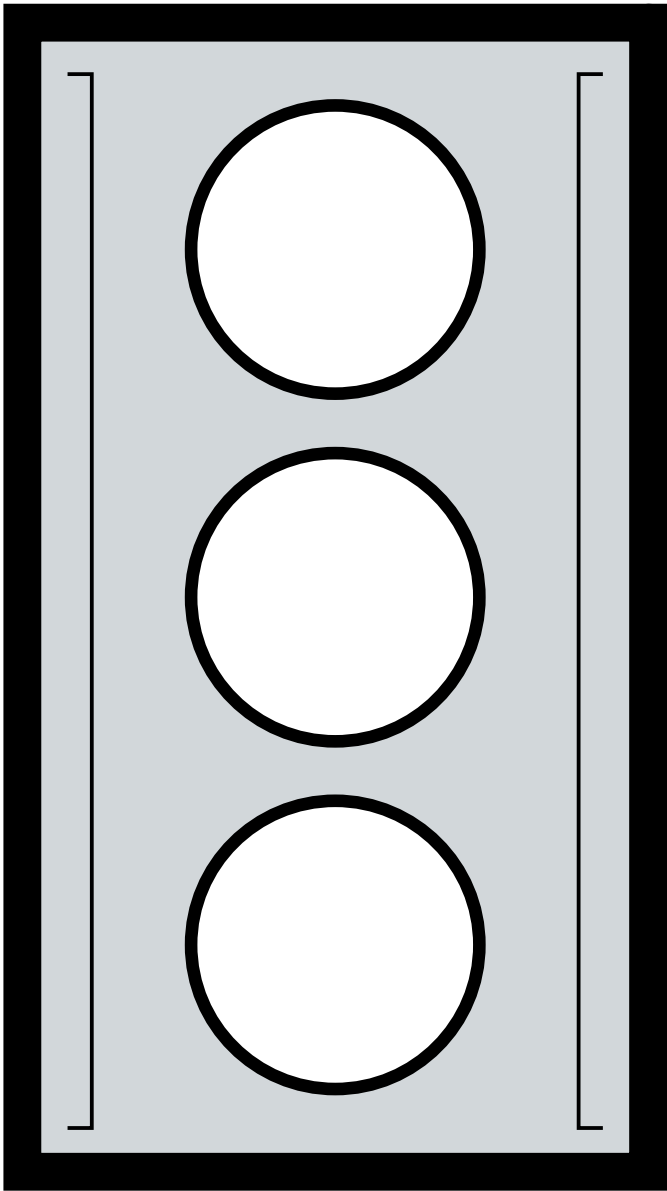

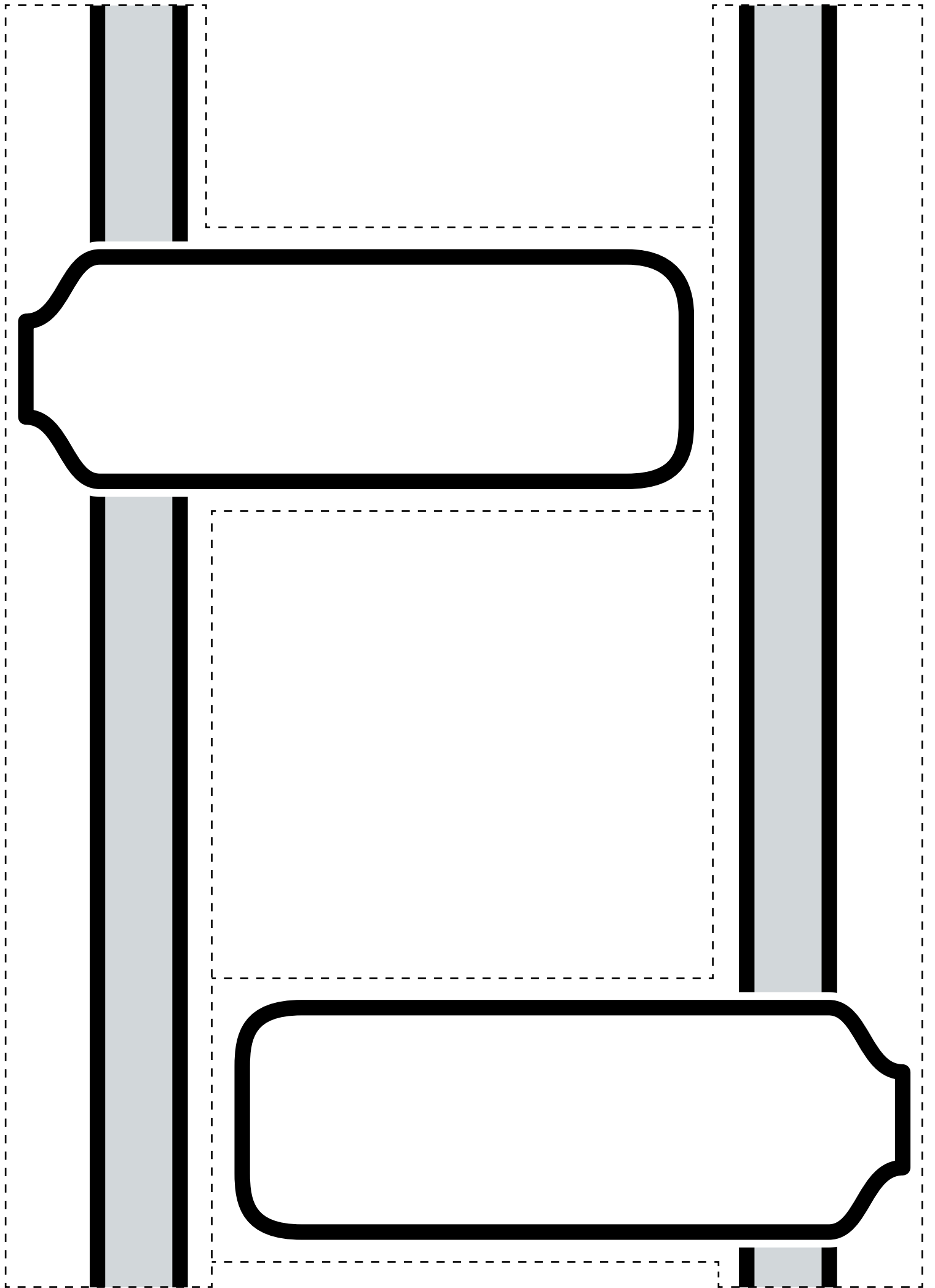

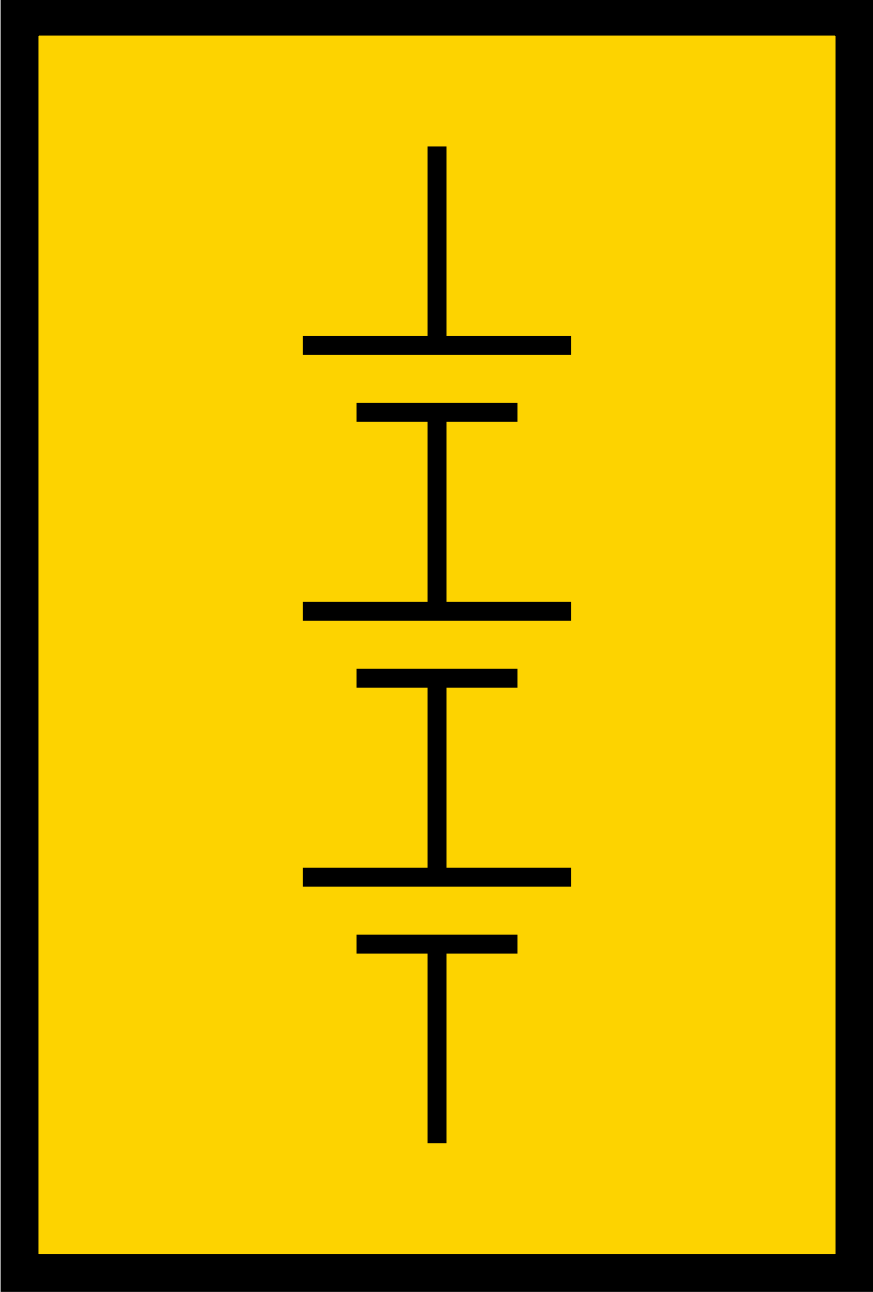



TECHNISCHE QUALIFIZIERUNG. GRUNDLAGEN HOCHVOLT-TECHNIK.

BMW GROUP HOCHVOLT-QUALIFIKATIONEN.

Verantwortlicher BMW Group Hochvolt-Experte vHVE

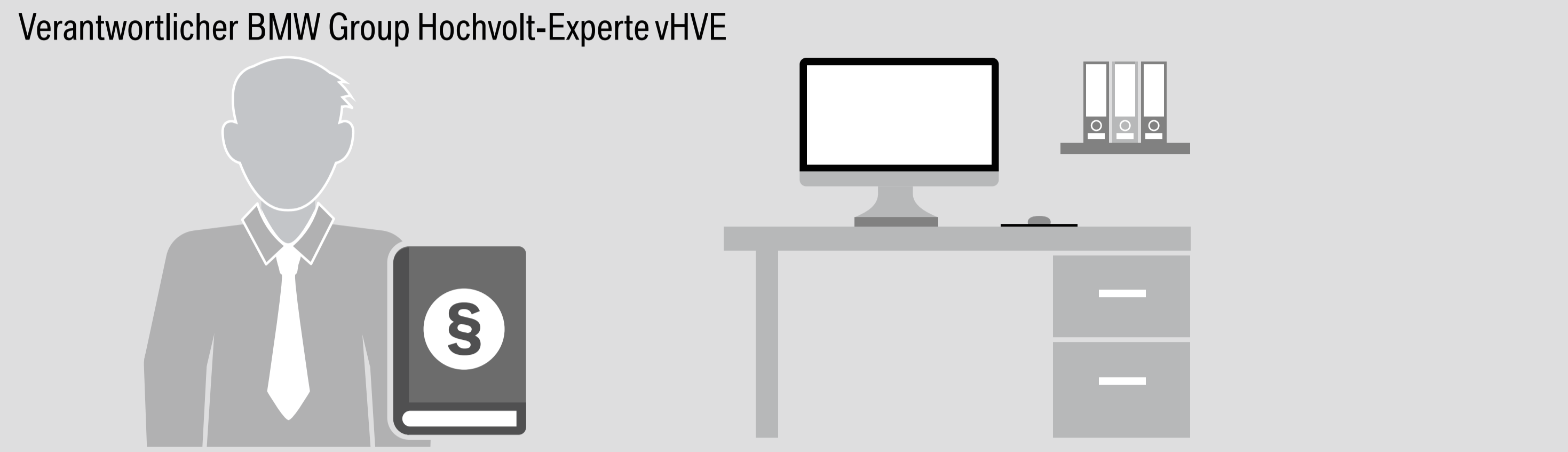

BMW Group Hochvolt-Experte HVE

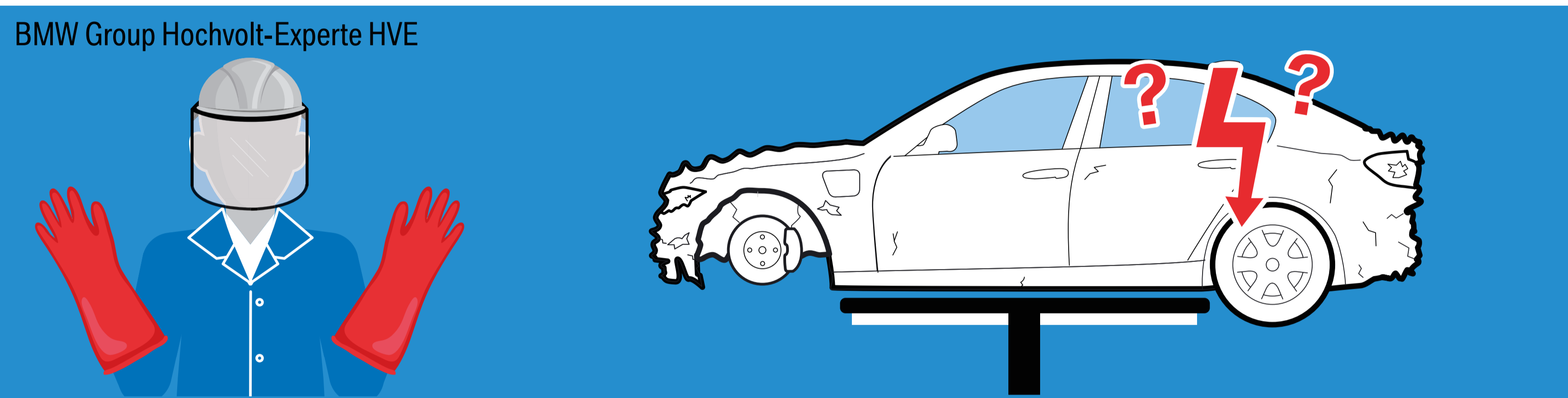

BMW Group Hochvolt-Techniker Plus

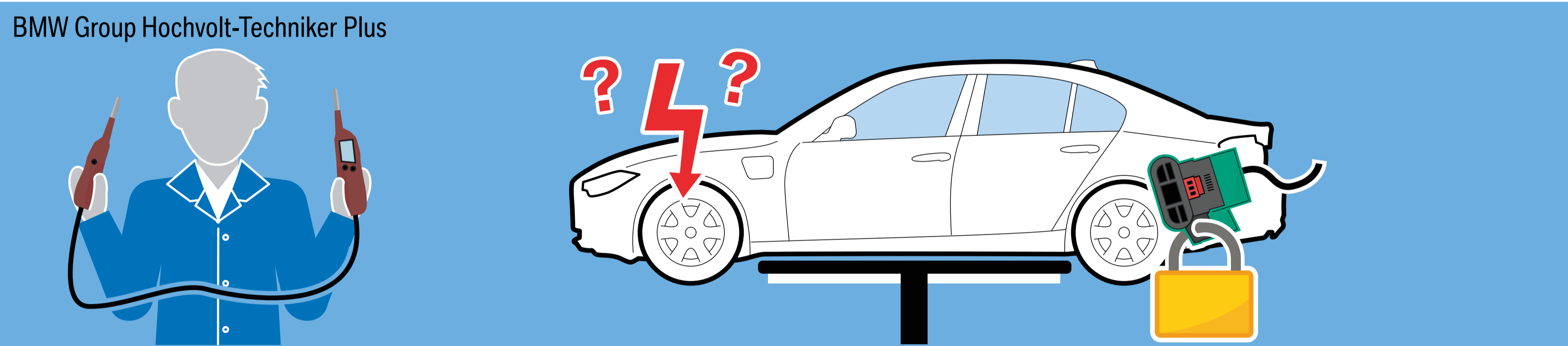

BMW Group Hochvolt-Techniker mit Batteriezerifizierung

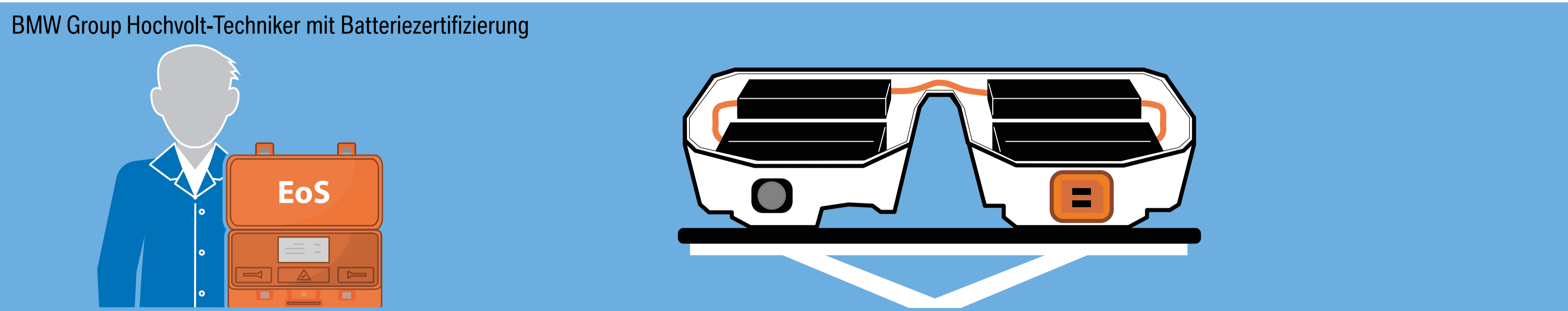

BMW Group Hochvolt-Techniker HVT

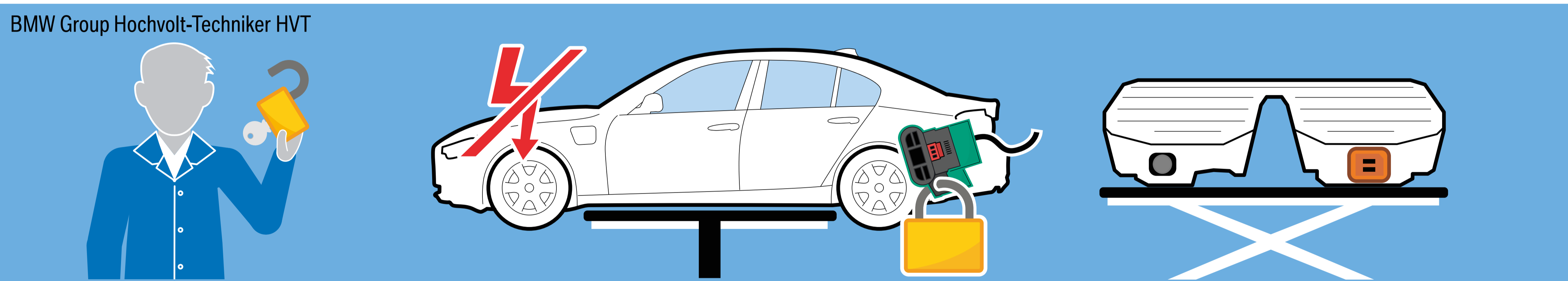

Elektrotechnisch unterwiesene Person EuP

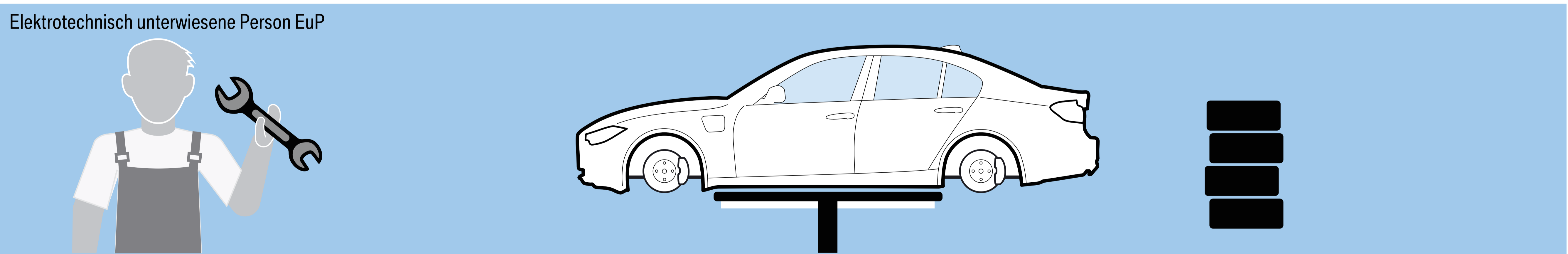

Elektrotechnischer Laie

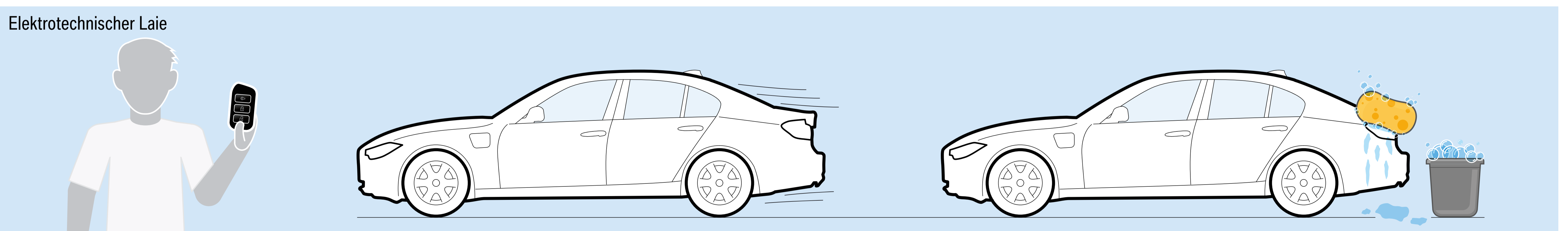

TECHNISCHE QUALIFIZIERUNG. GRUNDLAGEN HOCHVOLT-TECHNIK.

WIRKUNG DES STROMS.

Wechselstrom

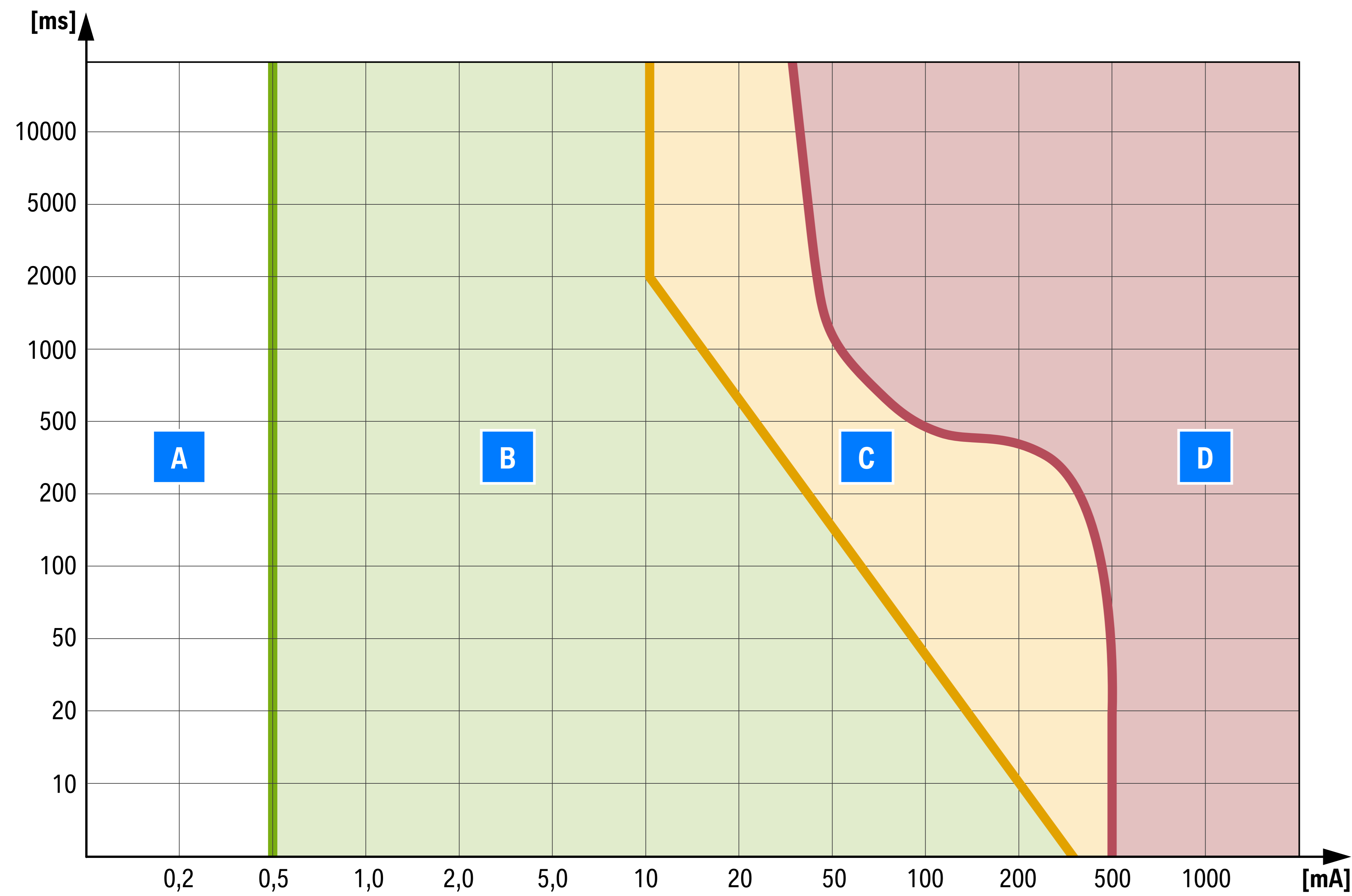

Gleichstrom

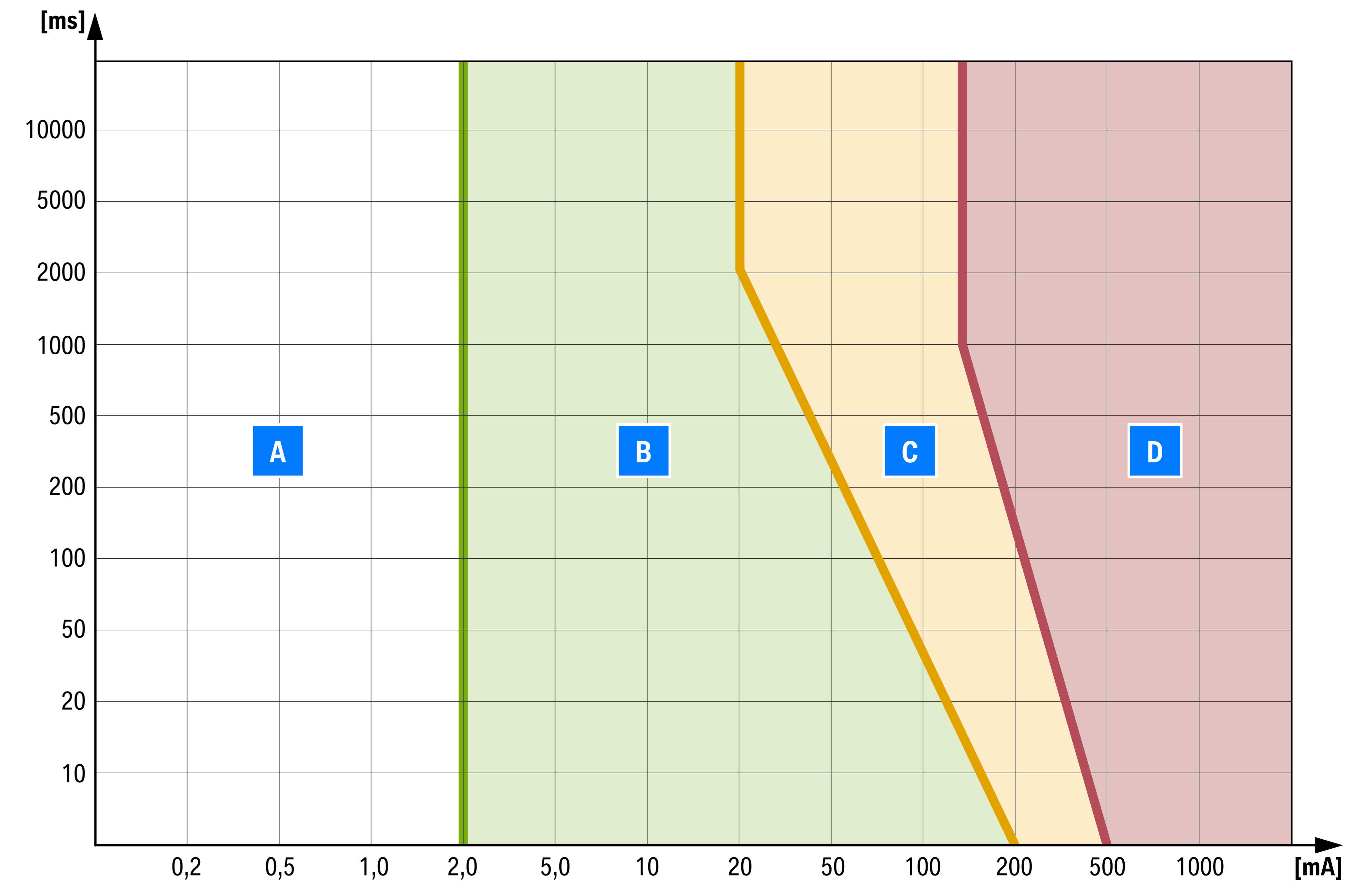

Index	Erklärung
A	Wirkung nicht spürbar
B	Wirkung spürbar, bis hin zur Muskelverkrampfung
C	Muskelverkrampfung, Schwierigkeiten beim Atmen
D	Herzkammerflimmern, Atemstillstand, Herzstillstand

TECHNISCHE QUALIFIZIERUNG. GRUNDLAGEN HOCHVOLT-TECHNIK.

RETTUNGSKETTE.

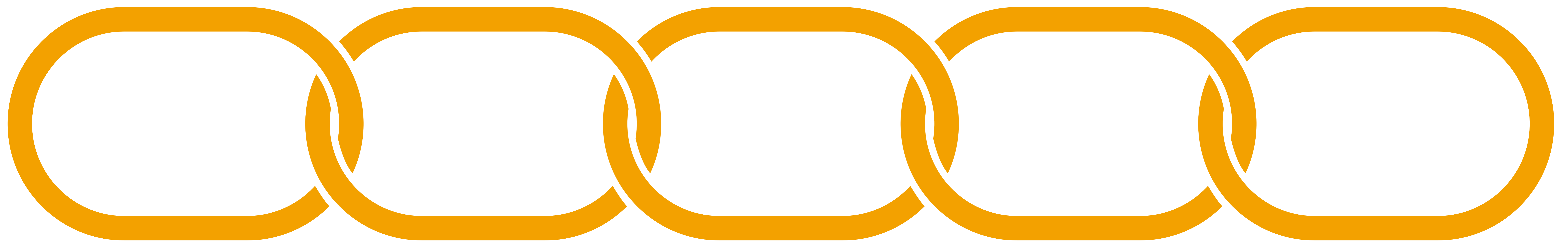

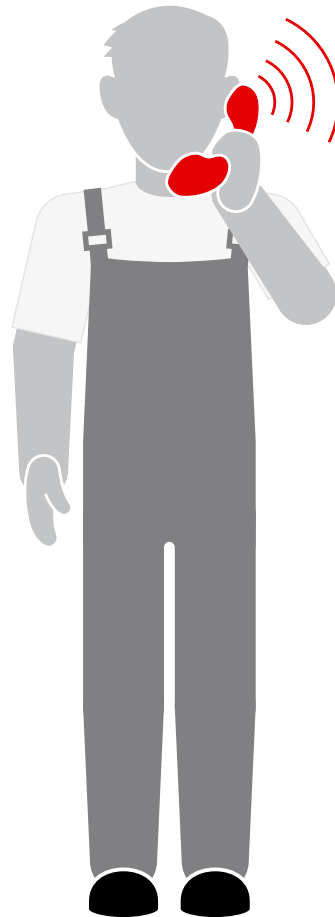
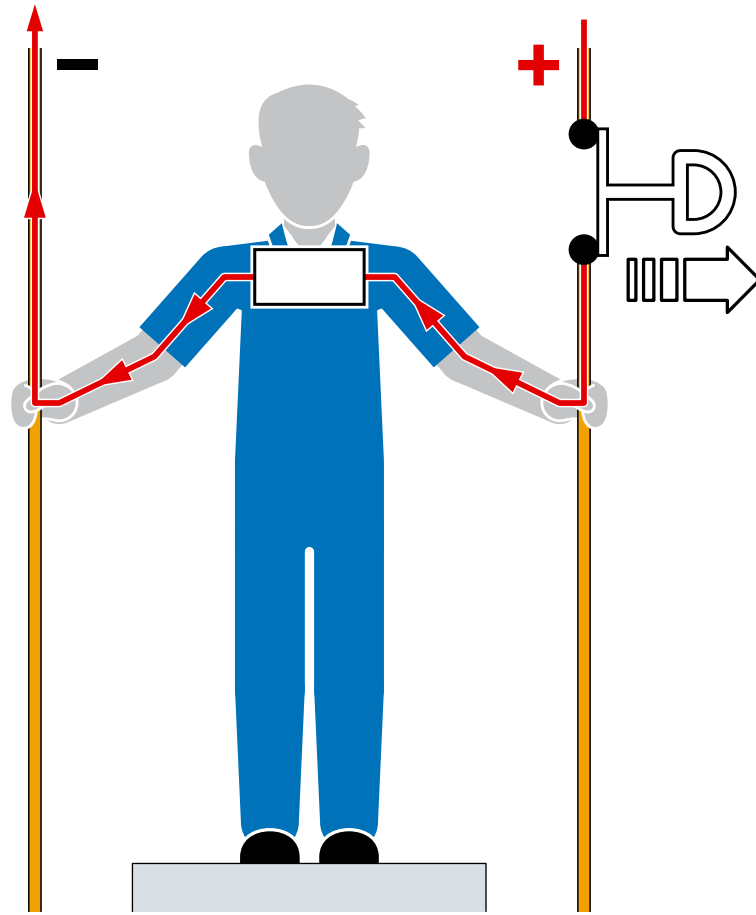

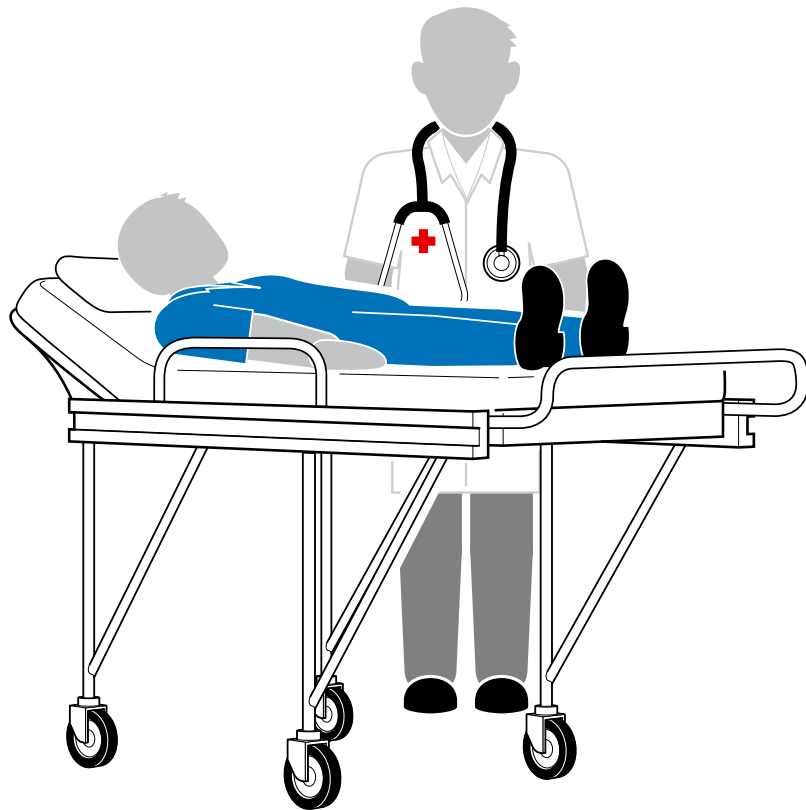

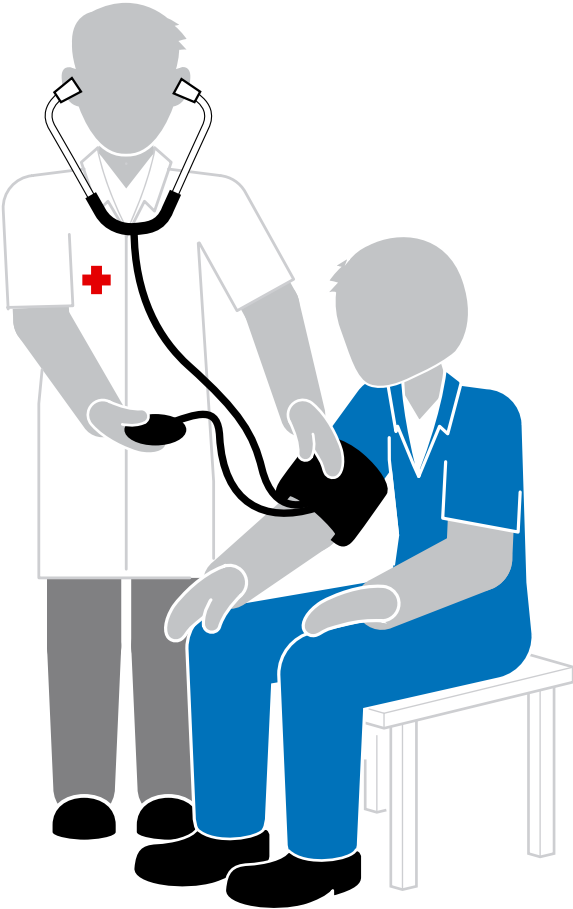

TECHNISCHE QUALIFIZIERUNG. GRUNDLAGEN HOCHVOLT-TECHNIK.

HOCHVOLT-KONTAKTÜBERWACHUNG.

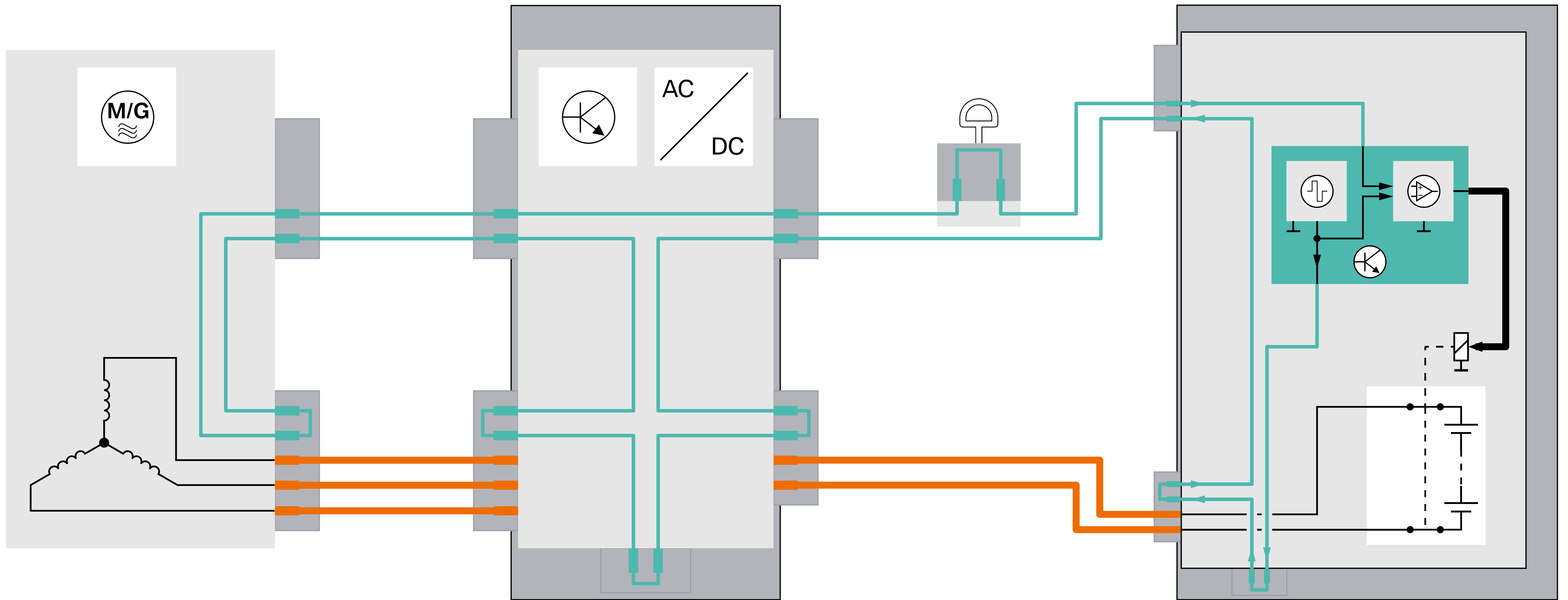

TECHNISCHE QUALIFIZIERUNG. GRUNDLAGEN HOCHVOLT-TECHNIK.

AUTOMATISCHES HERUNTERFAHREN DES HOCHVOLT-SYSTEMS.

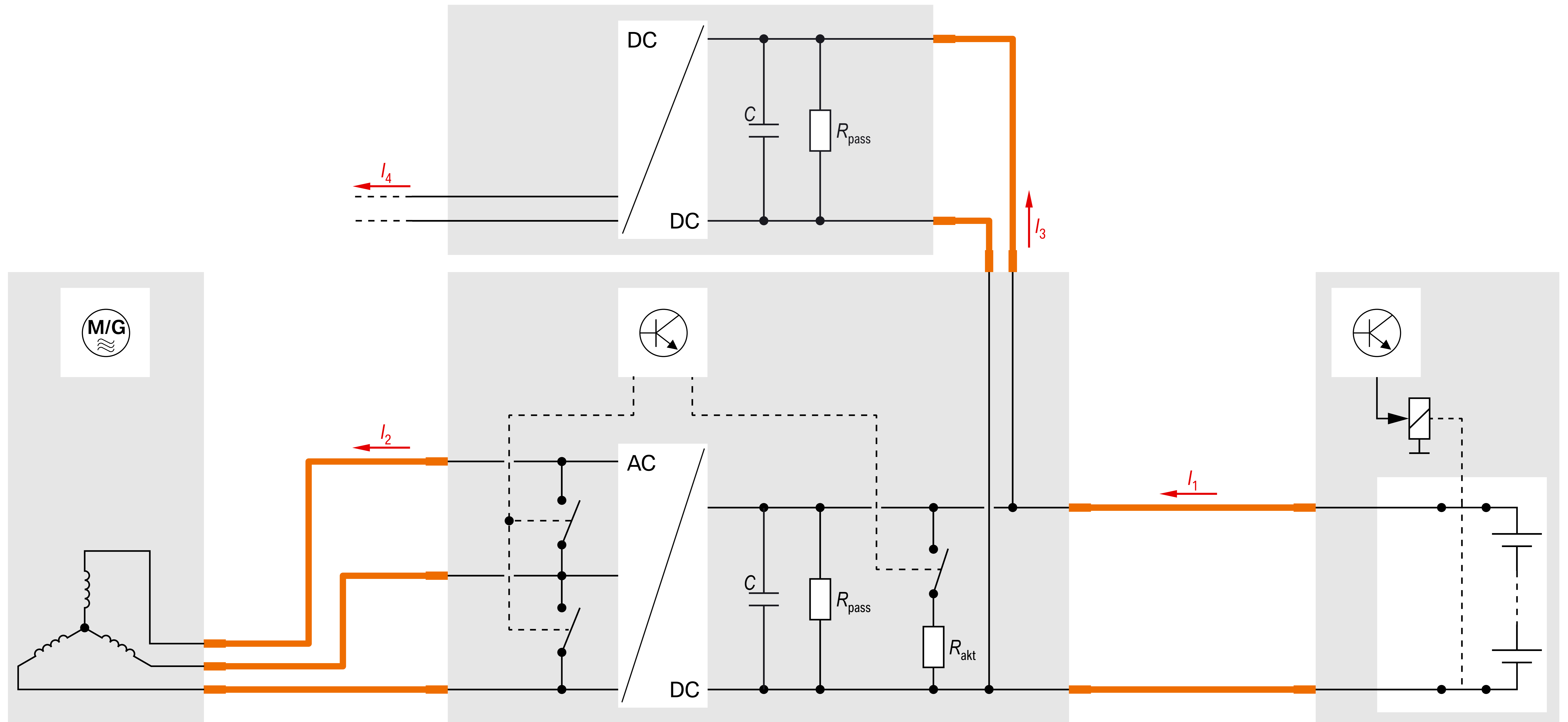





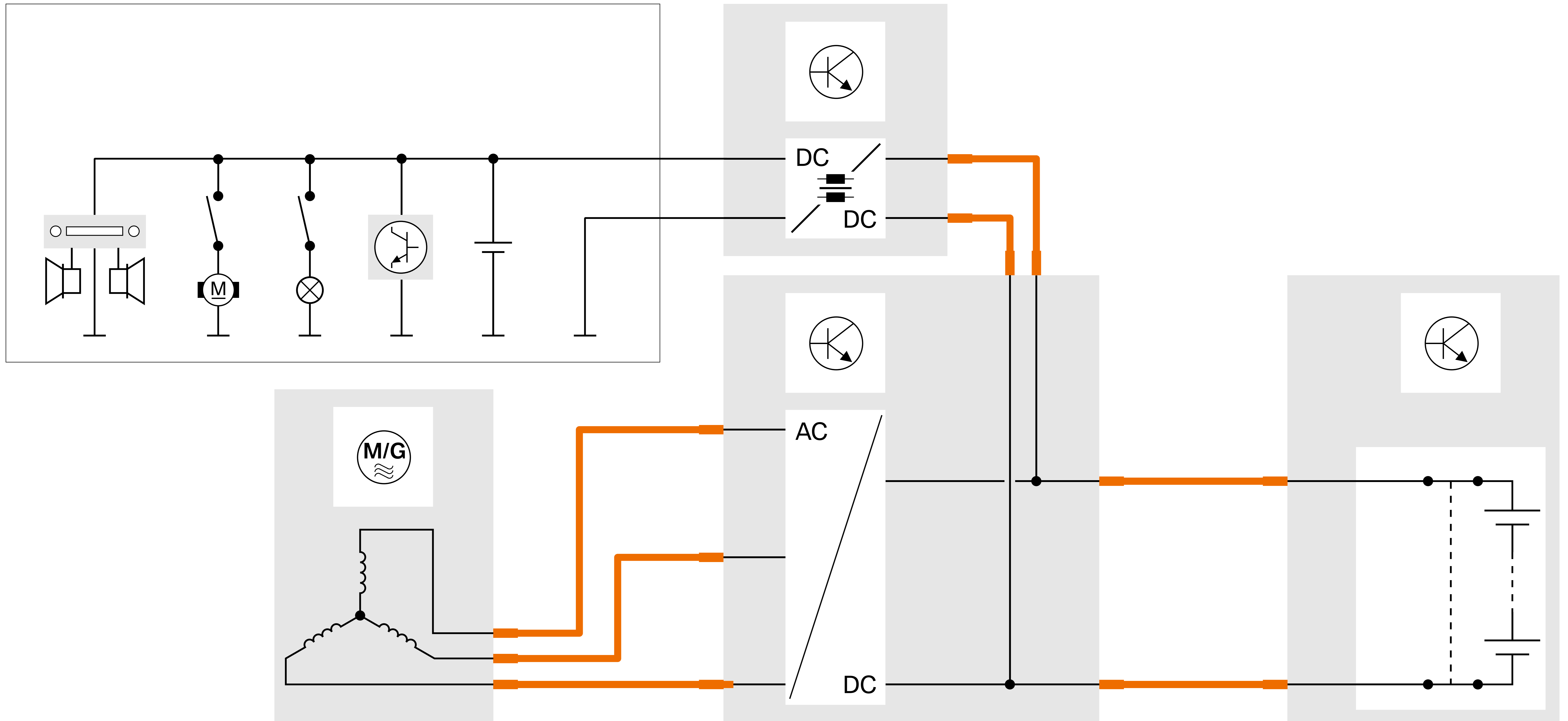





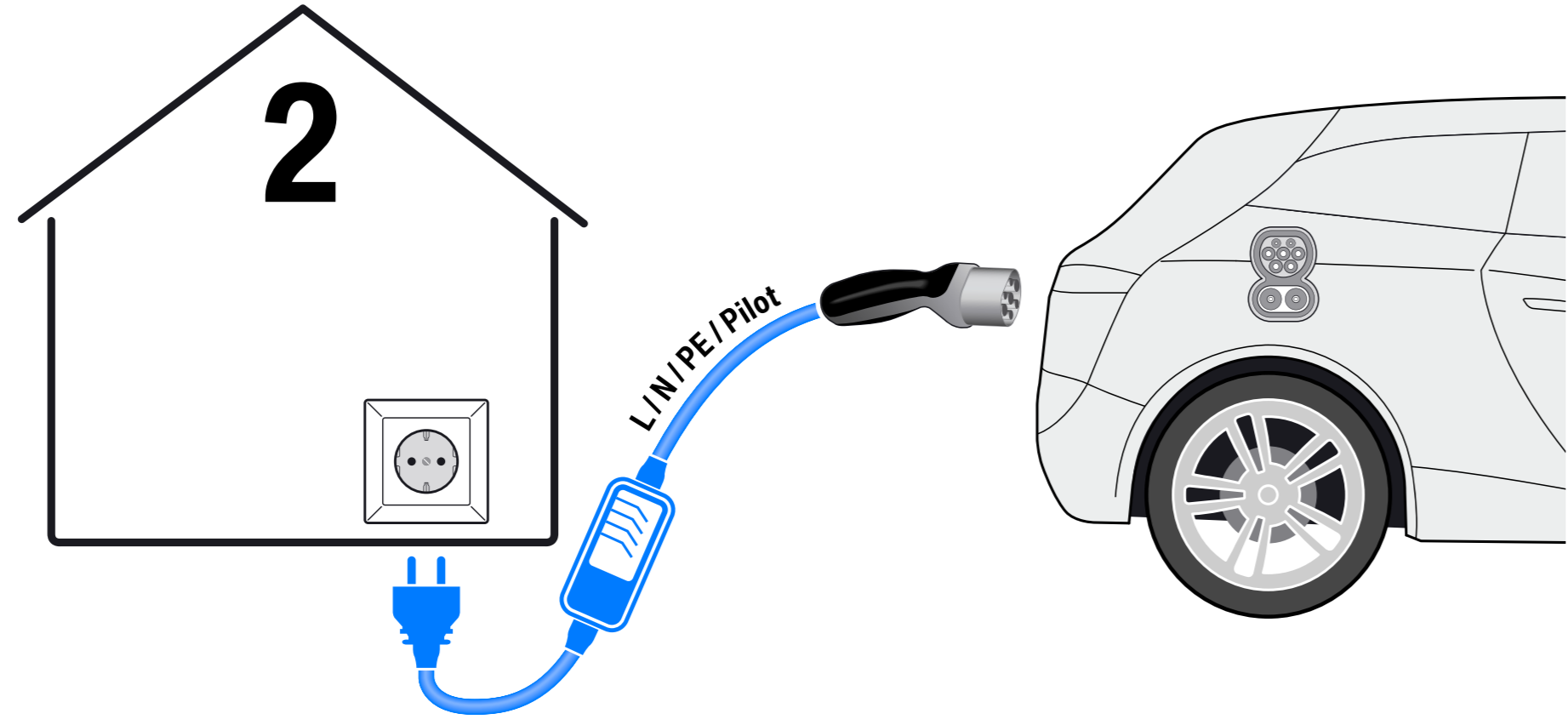
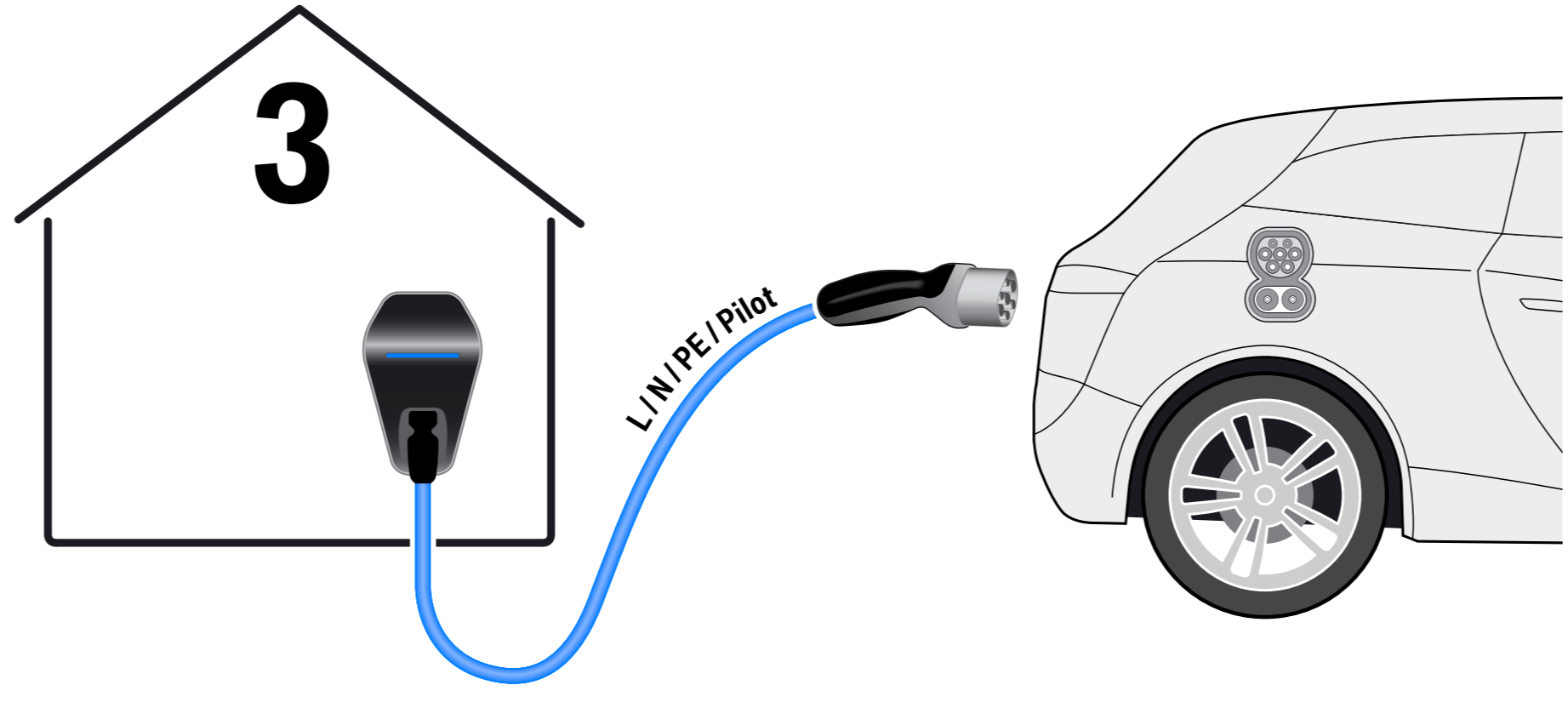
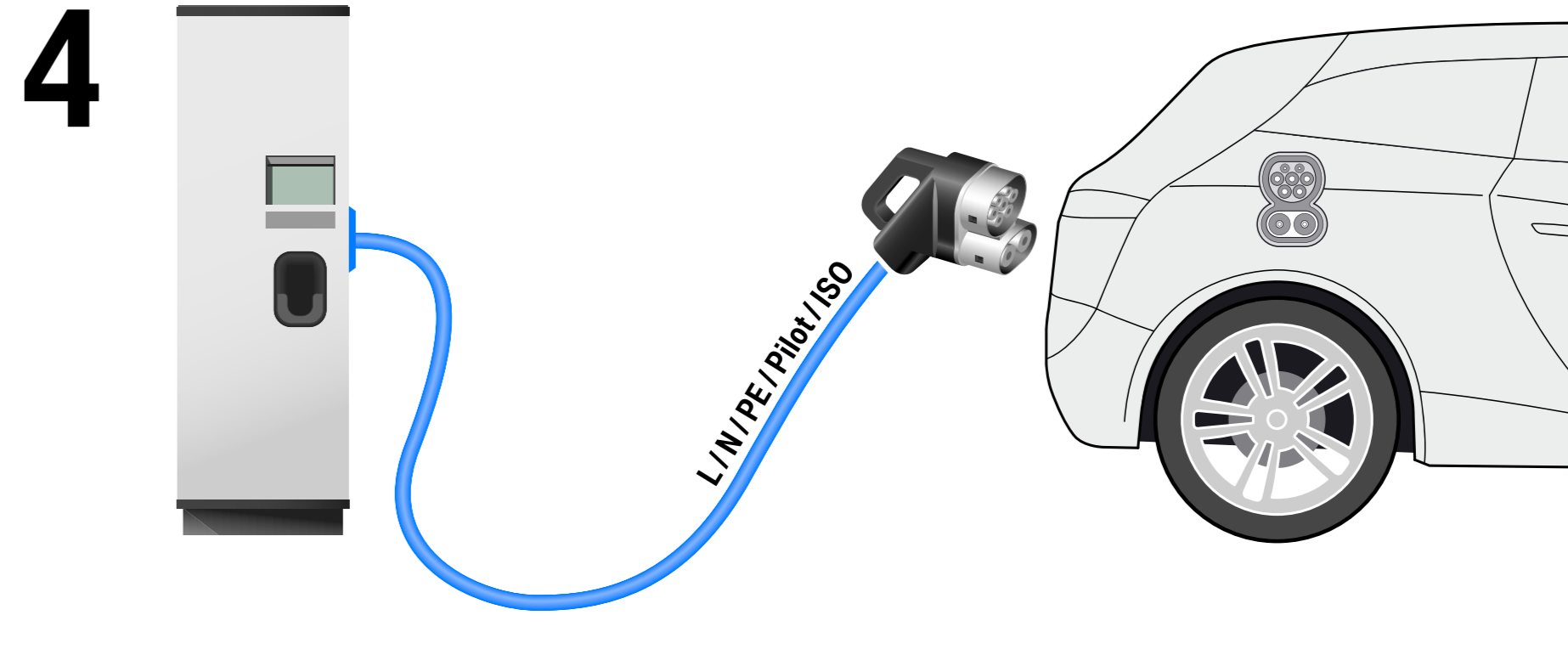





TECHNISCHE QUALIFIZIERUNG. GRUNDLAGEN HOCHVOLT-TECHNIK.

GALVANISCHE TRENNUNG HOCHVOLT- UND 12-V-BORDNETZ.



TECHNISCHE QUALIFIZIERUNG. GRUNDLAGEN HOCHVOLT-TECHNIK.

LADEÜBERSICHT.

	AC-Laden			DC-Laden			
Ladebetriebsart							
Ladevorrichtung	 Haushaltssteckdose	 Wallbox/Ladestation	 DC-Ladestation				
Ladezubehör	 Standard-Ladekabel	 Mode-3-Ladekabel	---				
Ladestandard	   Typ 1 Typ 2 GB/T	   Typ 1 Typ 2 GB/T	    CCS Combo Typ 1 CCS Combo Typ 2 GB/T CHAdeMO				

TECHNISCHE QUALIFIZIERUNG. GRUNDLAGEN HOCHVOLT-TECHNIK.

LEISTUNGSELEKTRONIK – WECHSELRICHTER.

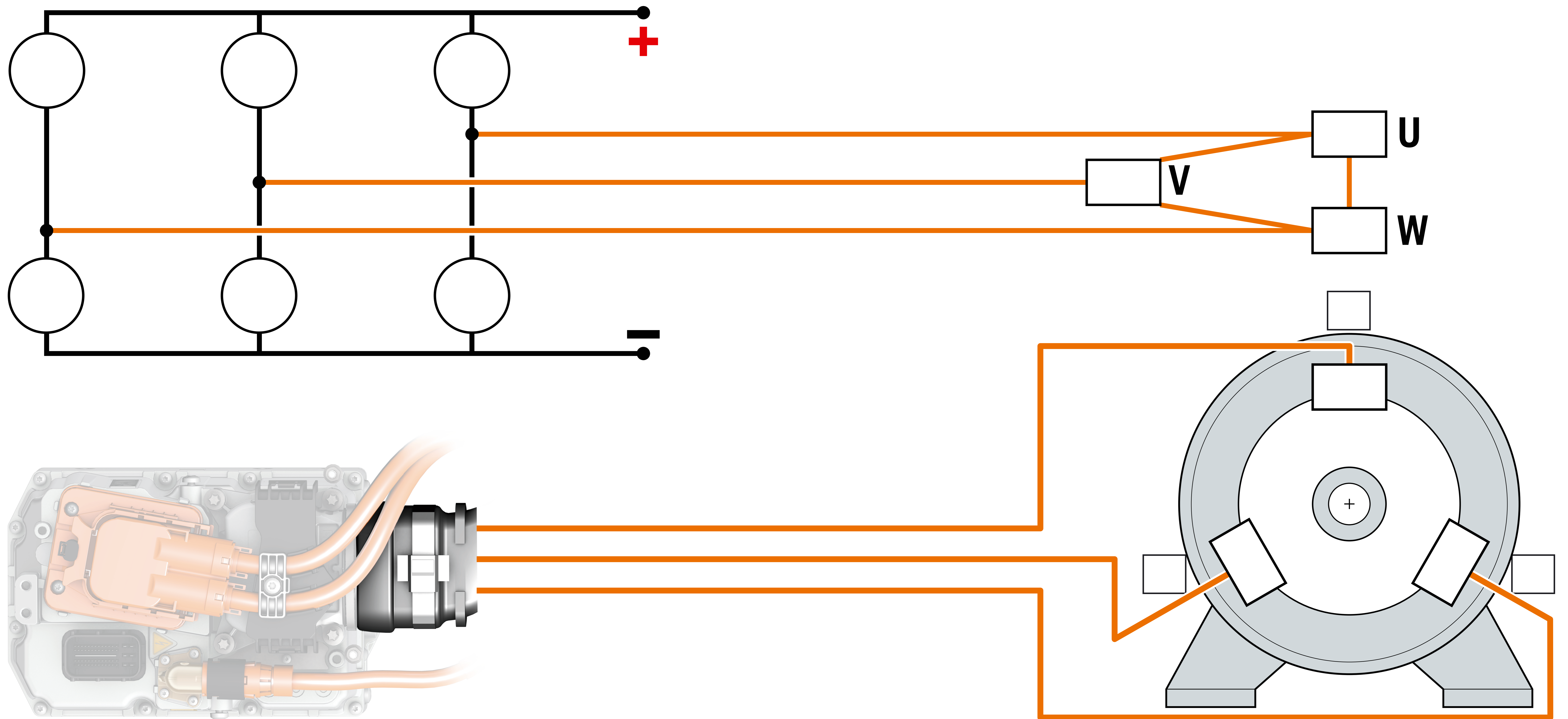

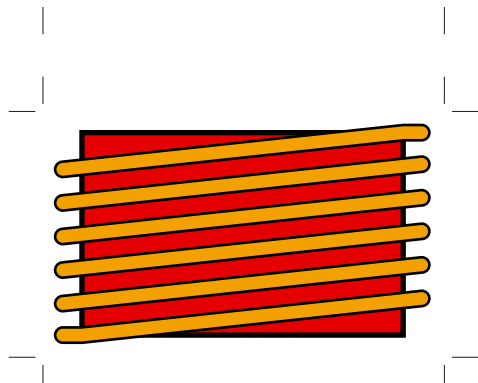
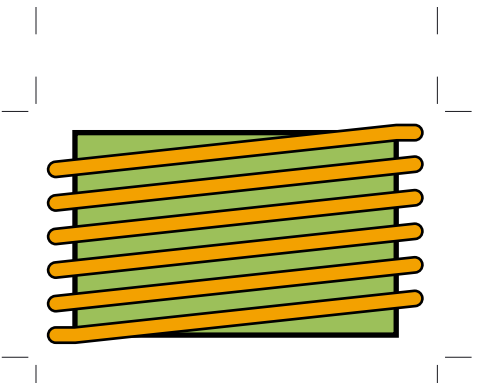
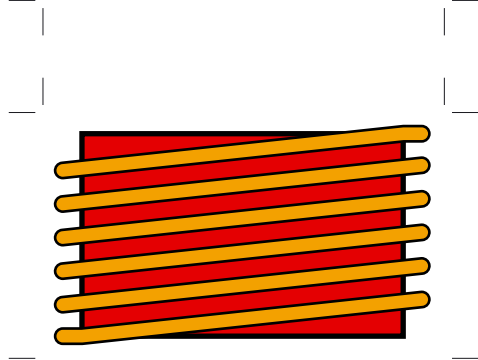
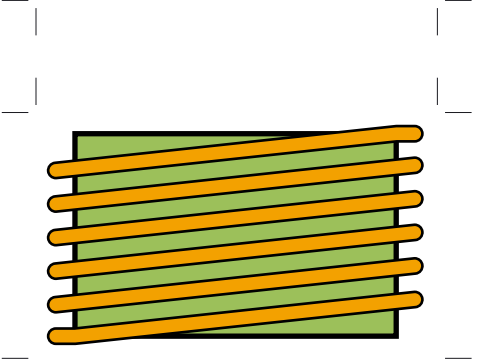
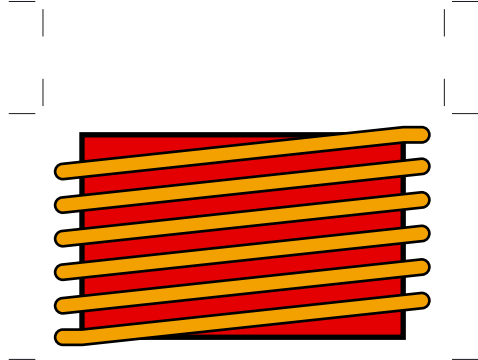
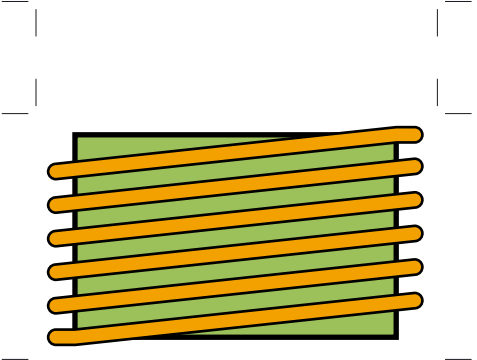
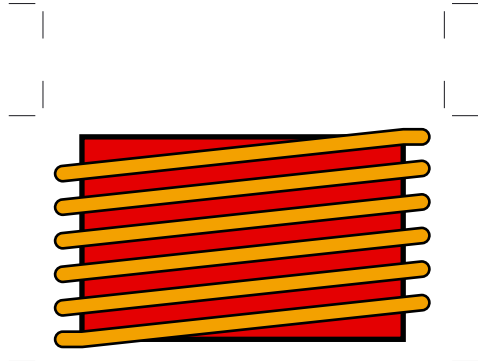
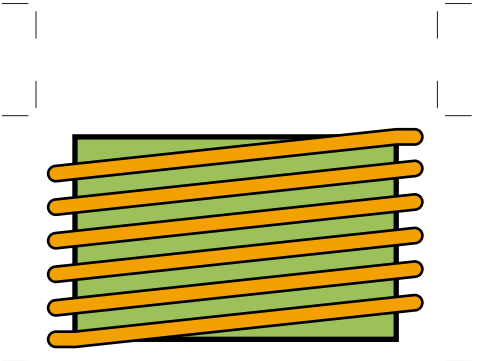
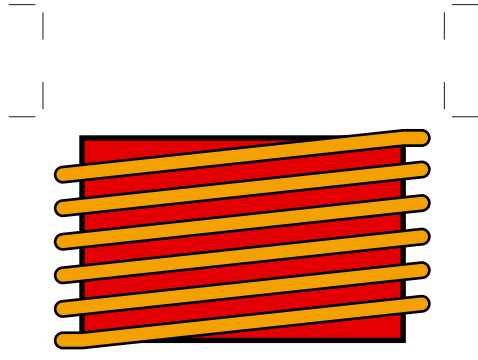
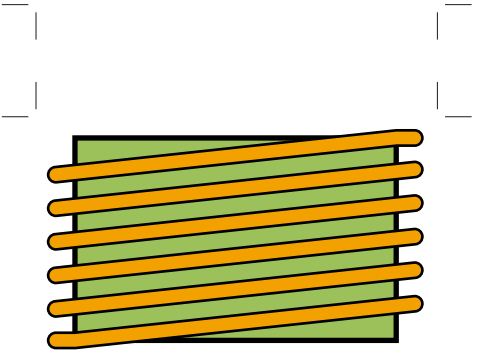
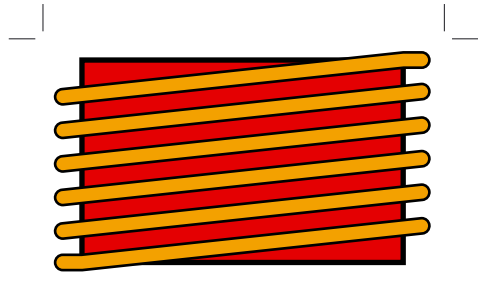
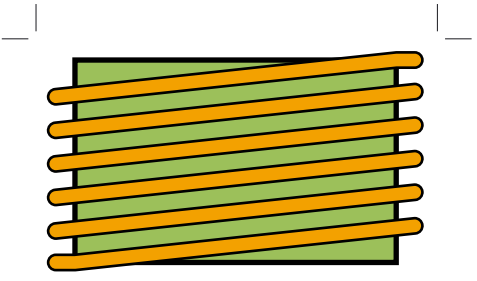

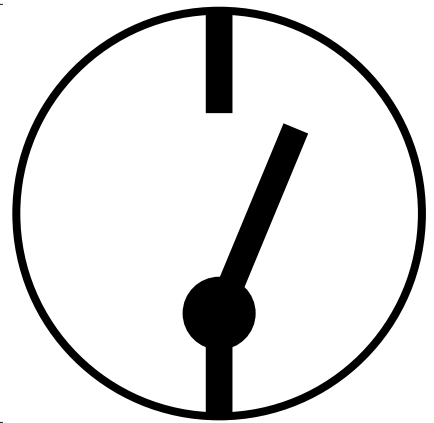
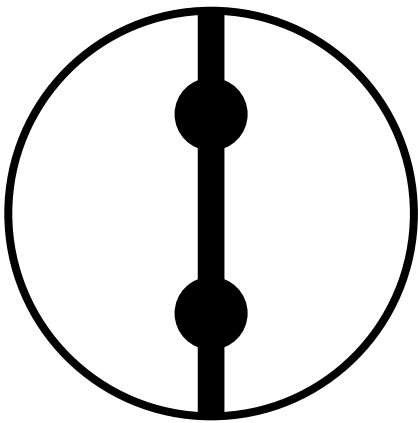
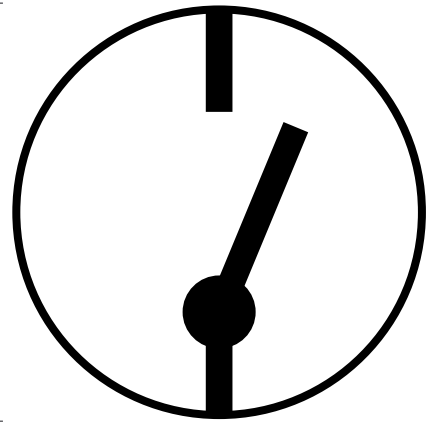
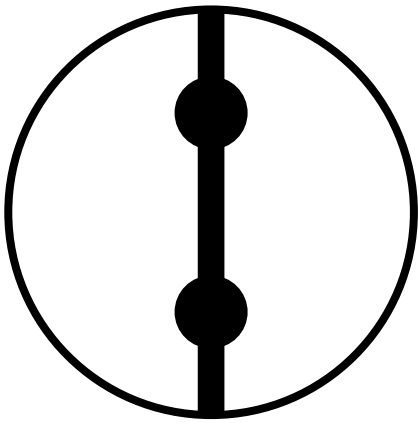
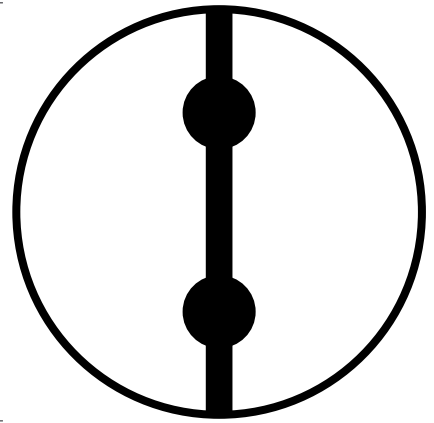
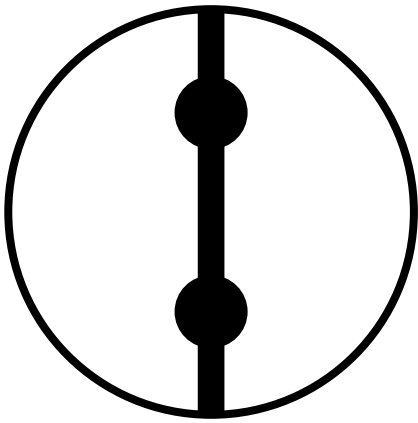
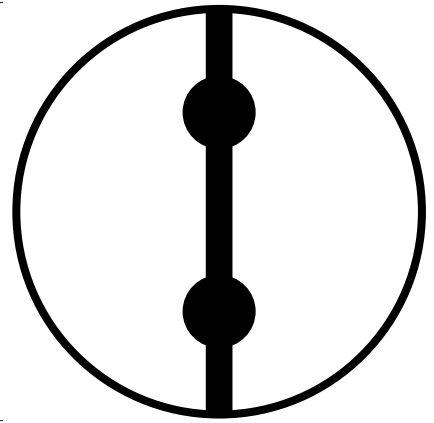
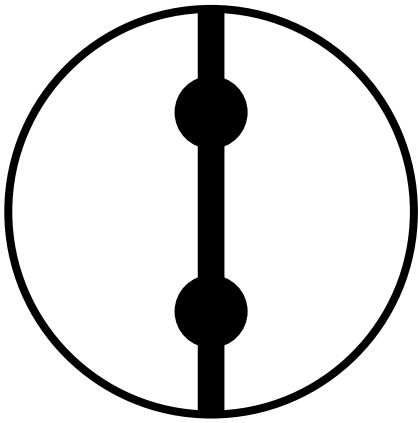

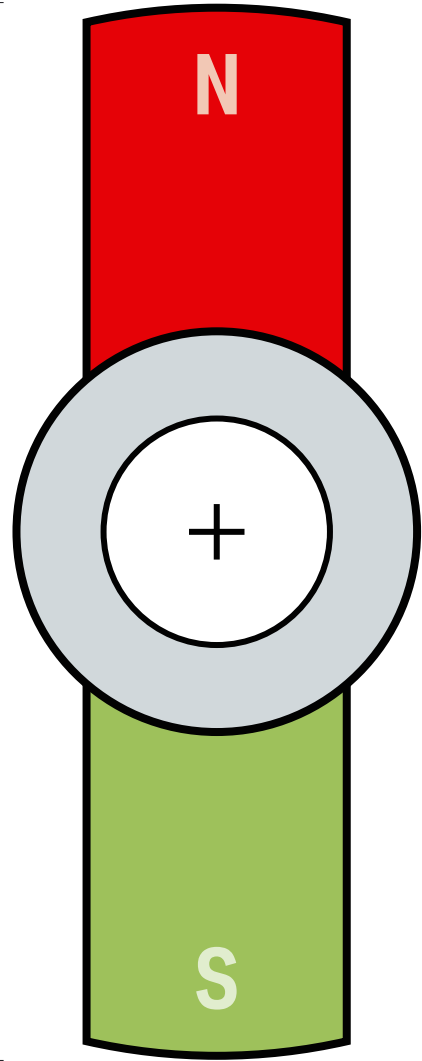
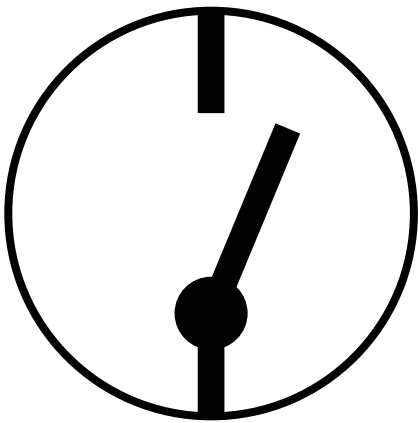
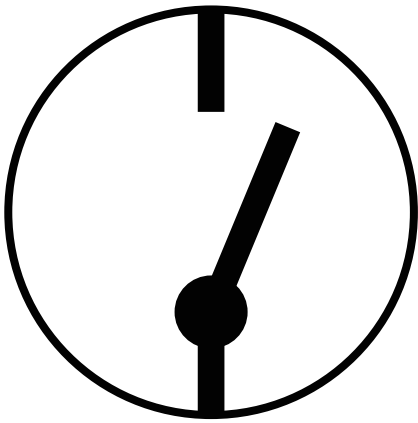
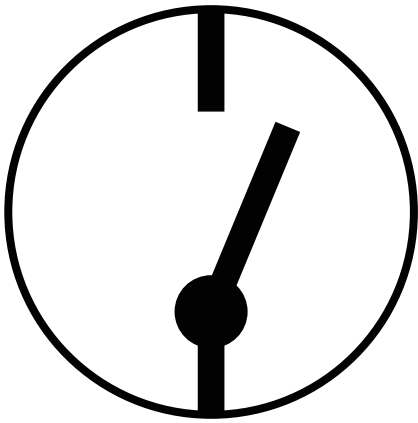
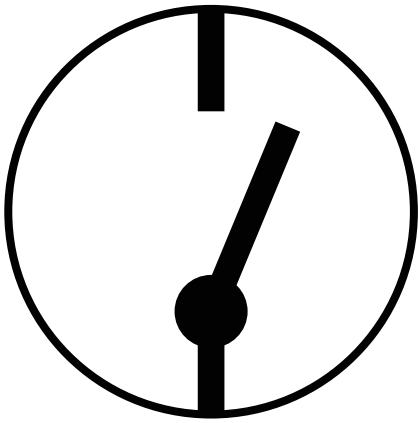

U

V

W

TECHNISCHE QUALIFIZIERUNG. GRUNDLAGEN HOCHVOLT-TECHNIK.

LEISTUNGSELEKTRONIK – GLEICHRICHTER.

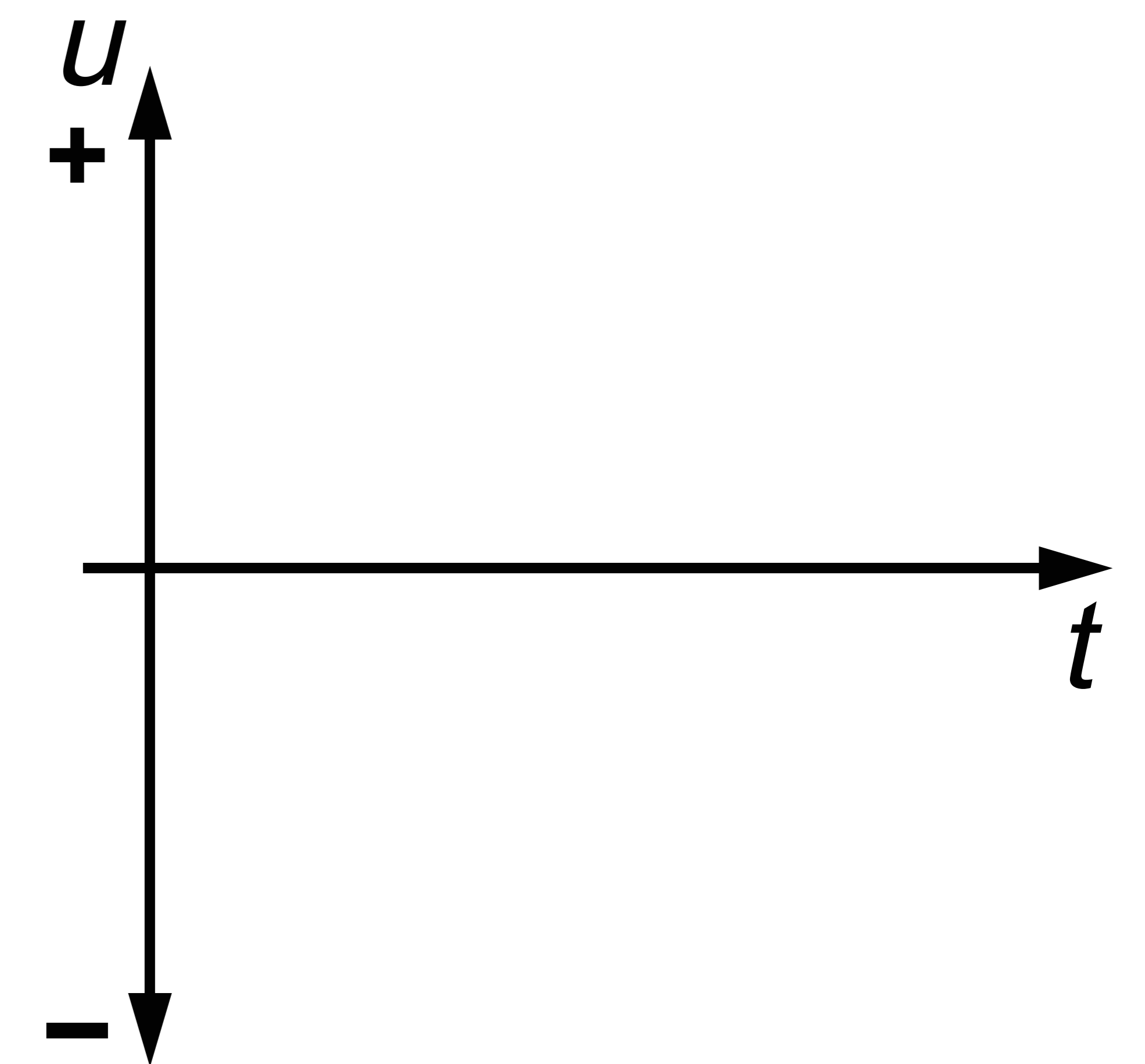
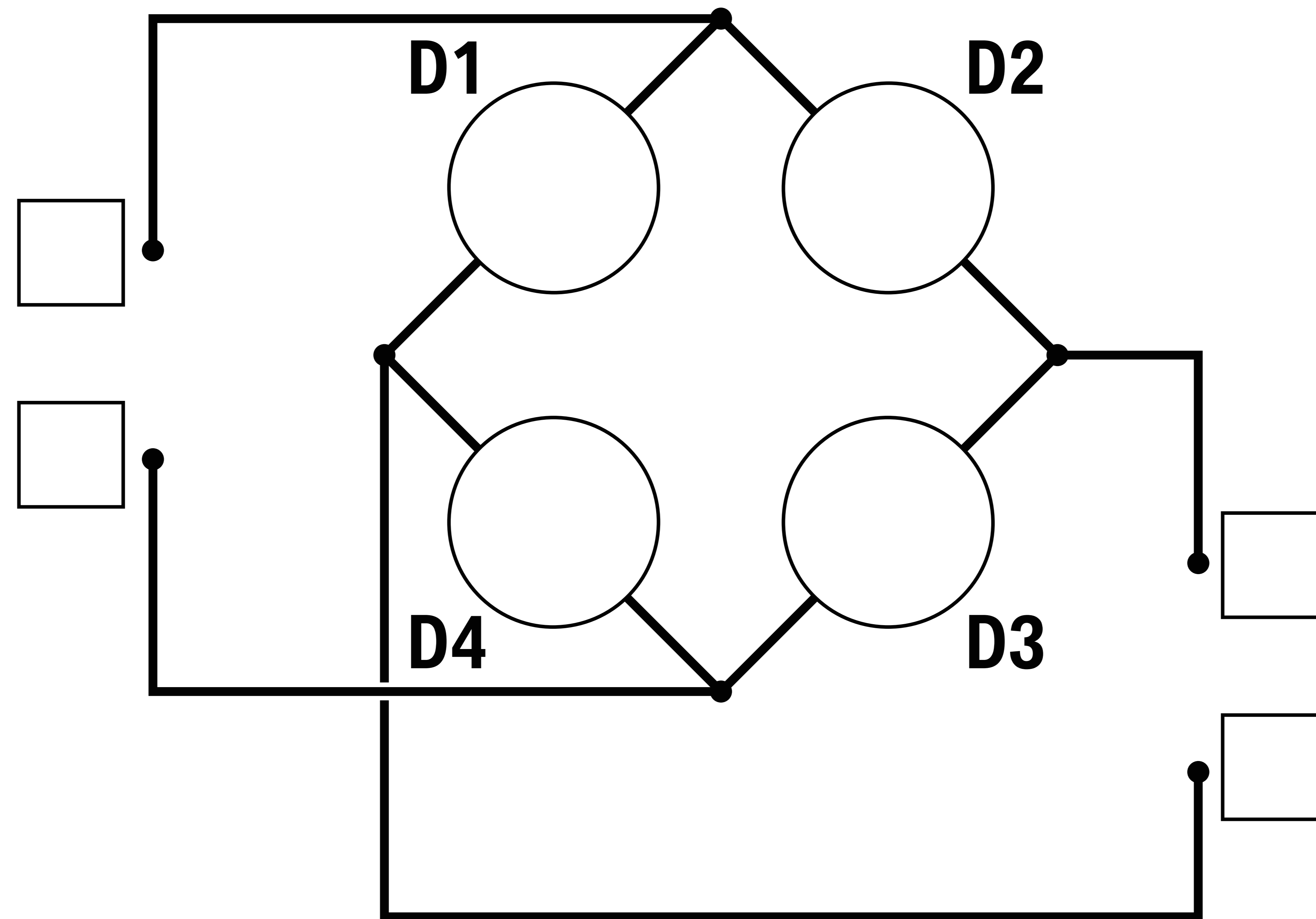
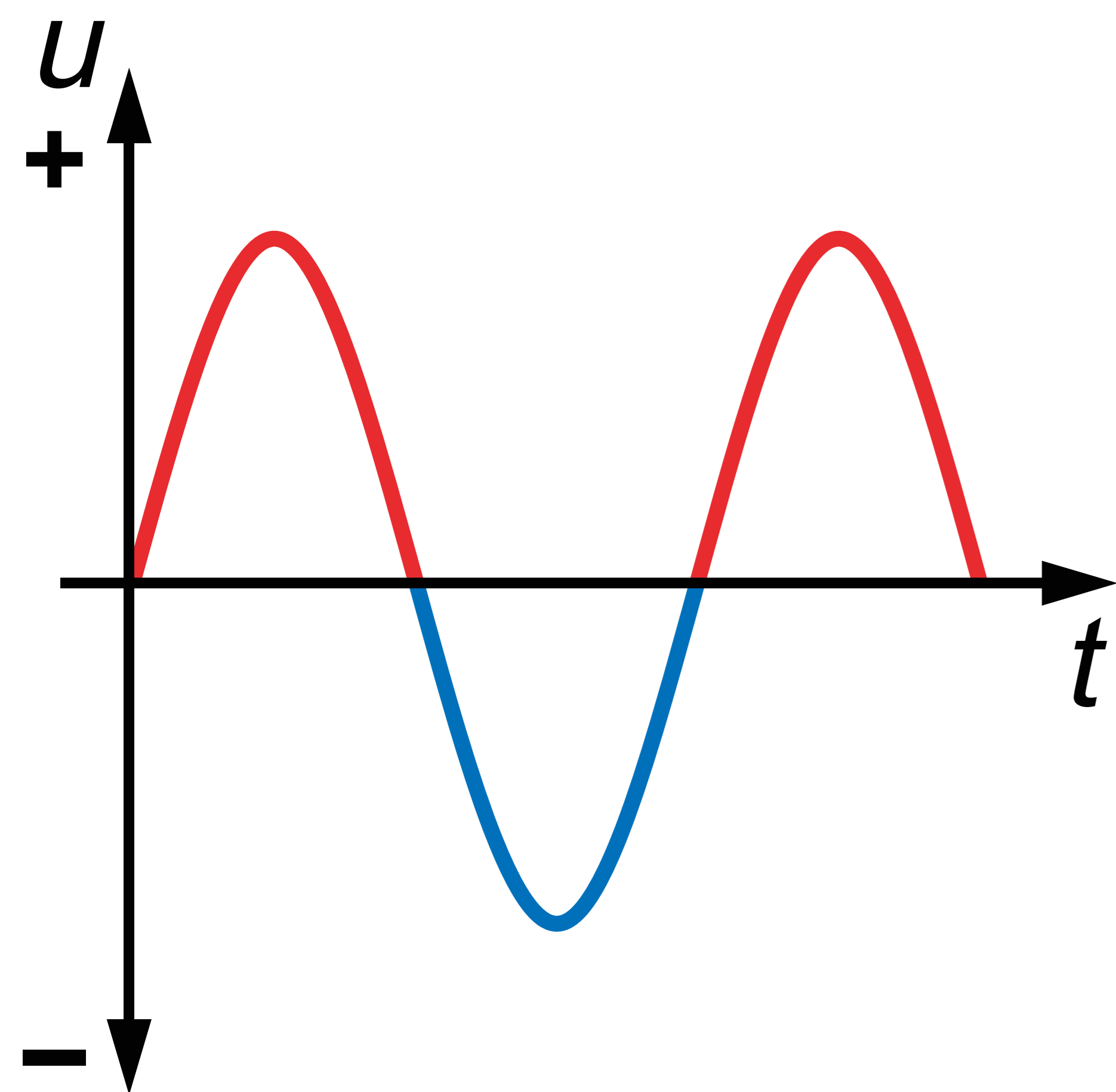

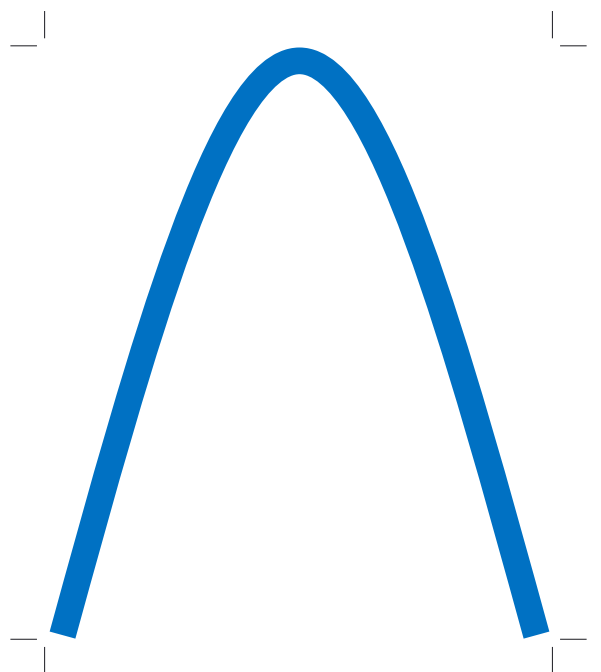
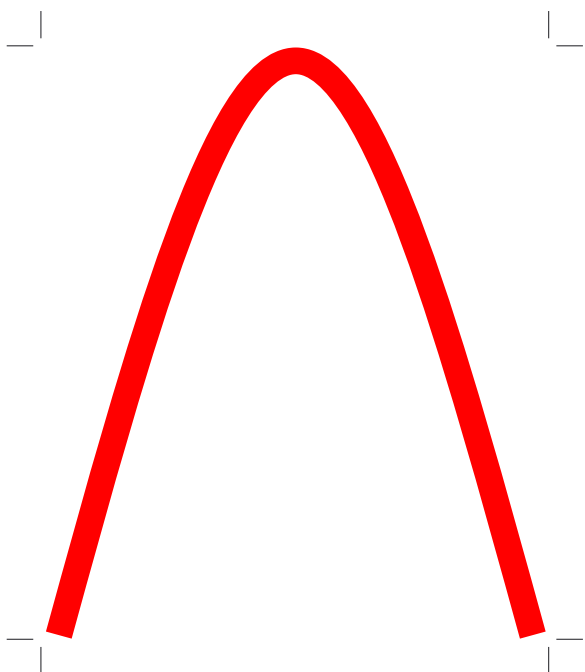
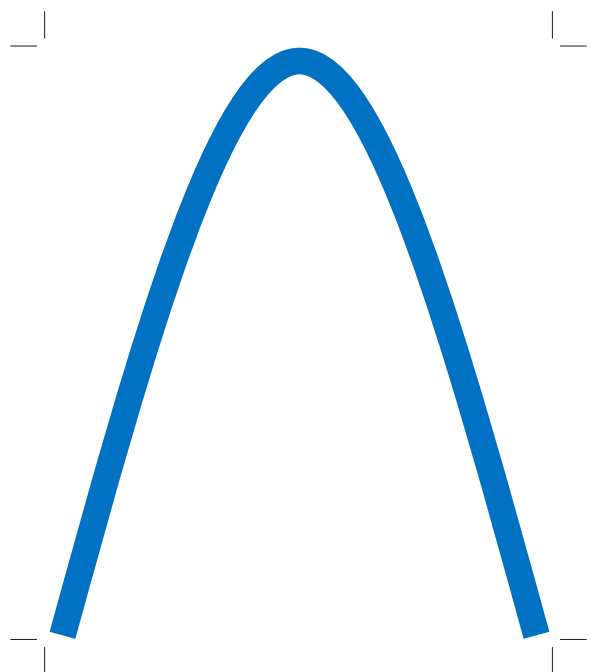
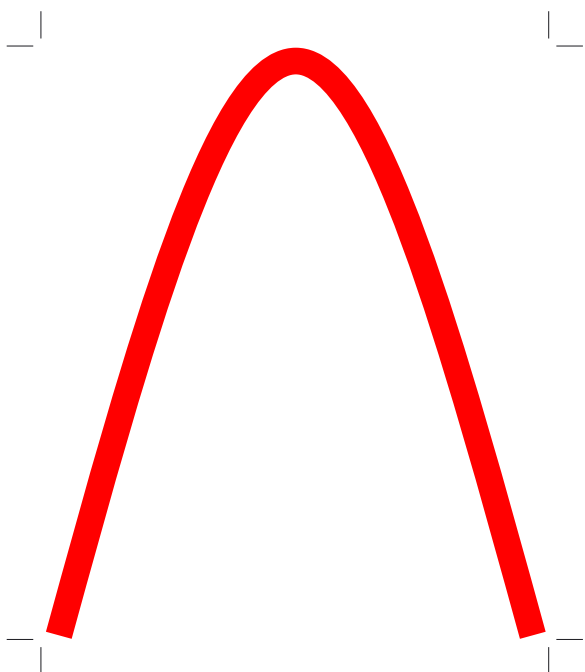
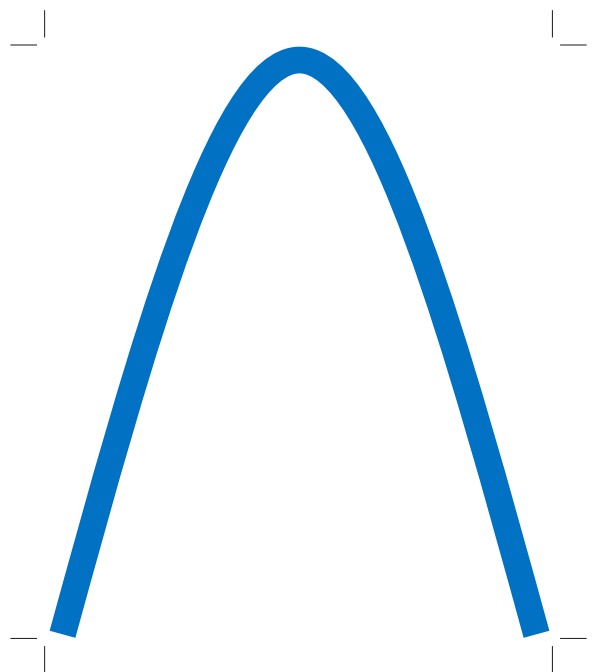
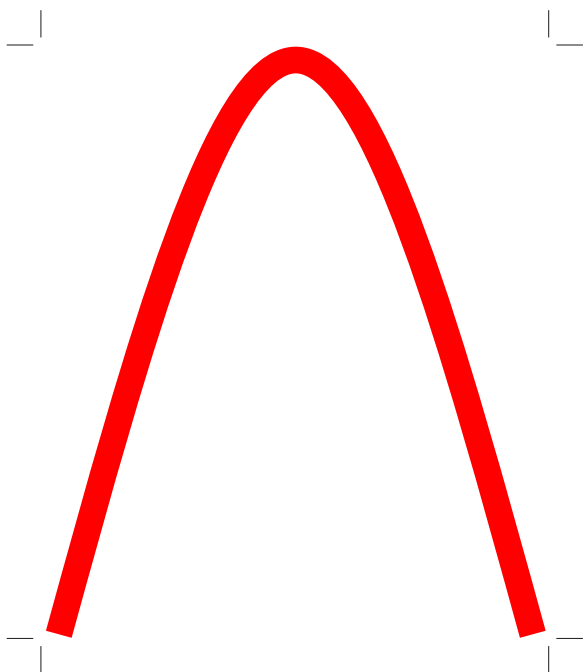

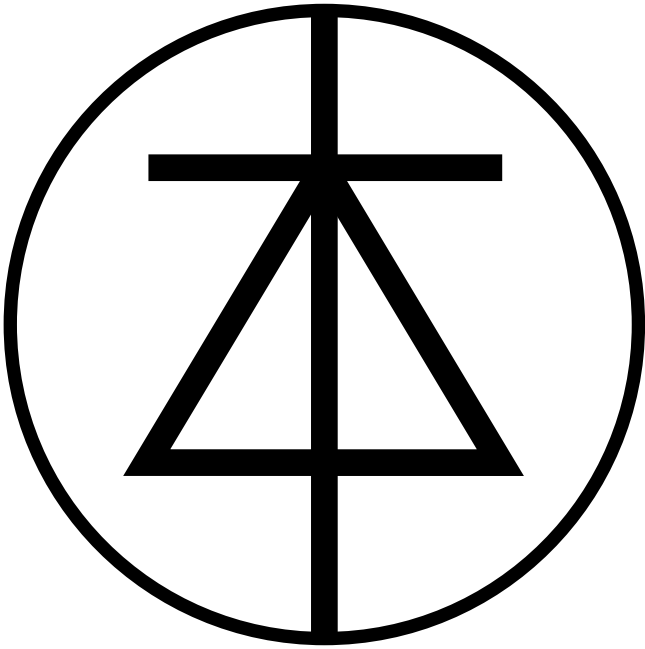
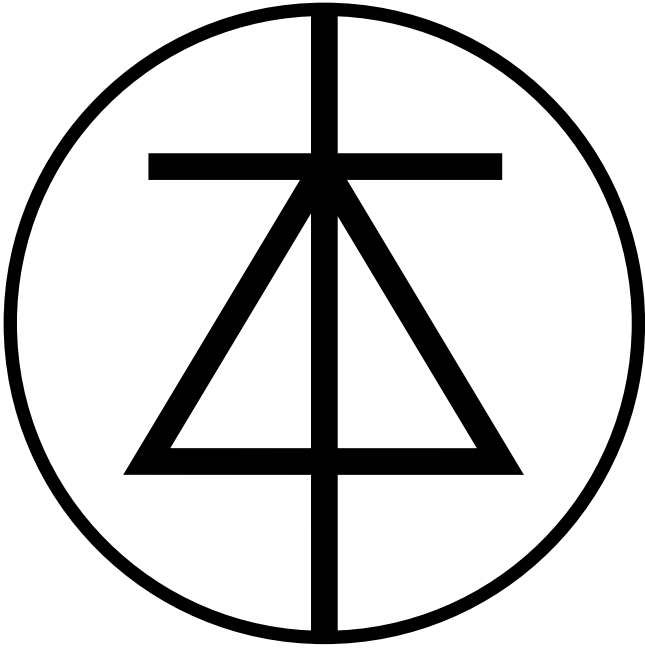

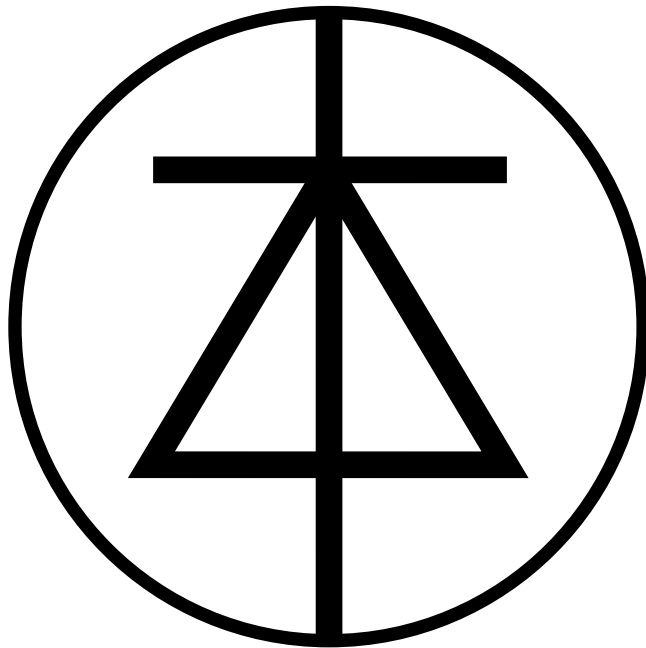
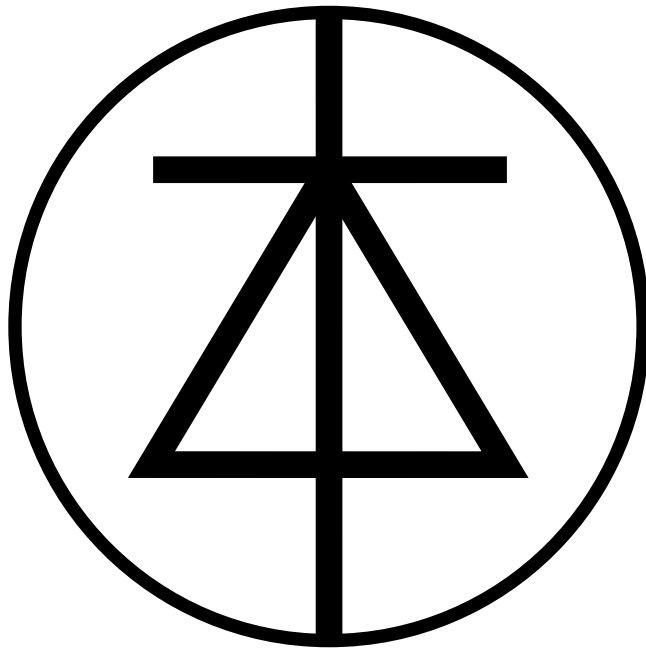

TECHNISCHE QUALIFIZIERUNG. GRUNDLAGEN HOCHVOLT-TECHNIK.

LEISTUNGSELEKTRONIK – DC/DC-WANDLER.

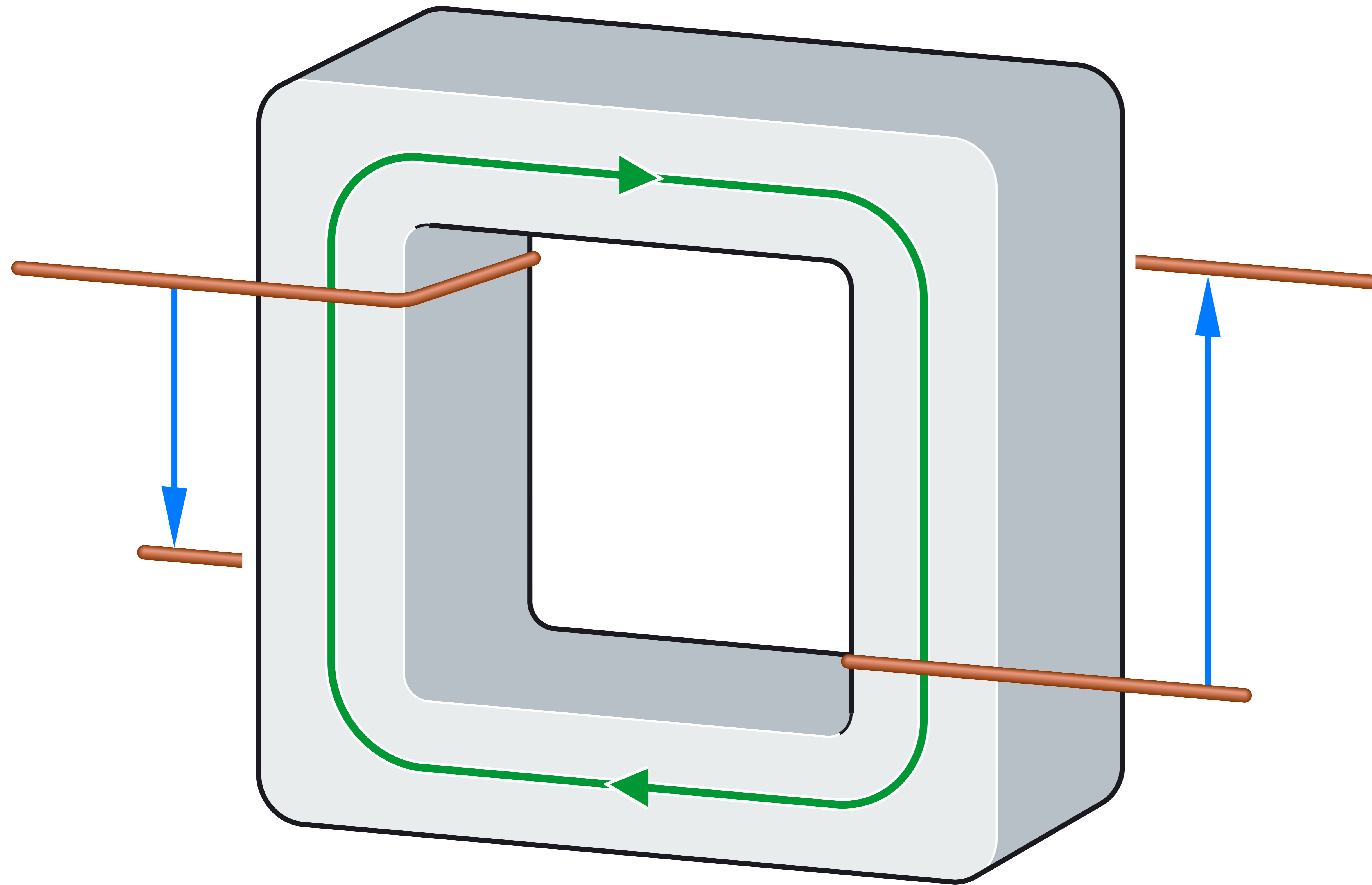

$$\frac{U_1}{U_2} = \frac{N_1}{N_2}$$

